



PRODUCT OVERVIEW 2020



HENCO PRODUCT OVERVIEW 2020



RADIATOR



SANITARY



FLOOR HEATING



GAS

EN/NL/FR/DE

EN/NL/FR/DE



PRODUCT OVERVIEW 2020

WE CARE TO CONNECT

Pipes		4	1
	A. STANDARD (PE-Xc/AL/PE-Xc)	5	
	B. RIXc (PE-Xc/AL/PE-Xc)	12	
	C. FLOOR-RIXc (PE-Xc/AL/PE-Xc)	15	
	D. PE-Xc	16	
	E. PE-RT	17	
	F. PROTECTION HOSE	18	
	G. GAS STANDARD (PE-Xc/AL/PE-Xc)	19	
	H. SPRINKLER	20	
Henco Press		21	2
	A. PK	22	
	B. PKW	35	
	C. PKG	42	
	D. PKS (SPRINKLER)	47	
	E. SUPER SIZE	53	
	F. HENCO ECOLINE	59	
Henco Vision		60	3
	A. SK	61	
	B. MANIFOLDS	67	
Brass Press fittings		72	4
	A. P	73	
	B. PG	87	
Brass Compression fittings		91	5
Manifolds		100	6
Valves		106	7
Underfloor heating		112	8
	A. SYSTEMS	113	
	B. MANIFOLDS	125	
	C. CONTROL UNITS	136	
	D. GEOTHERMAL	146	
Cabinets		147	9
Tools		149	10
Accessories		171	11
Certificates		175	



	<i>Page</i>
A. STANDARD (PE-Xc/AL/PE-Xc)	5
B. RIXc (PE-Xc/AL/PE-Xc)	12
C. FLOOR-RIXc (PE-Xc/AL/PE-Xc)	15
D. PE-Xc	16
E. PE-RT	17
F. PROTECTION HOSE	18
G. GAS STANDARD (PE-Xc/AL/PE-Xc)	19
H. PKS	20

A. STANDARD (PE-Xc/AL/PE-Xc)



Type: COIL



Henco multilayer pipe (Coil)
 Henco meerlagenbuis (Rol)
 Henco tube multicouche (Rouleau)
 Henco Mehrschichtverbundrohr (Ring)

Article number	m / Pallet	Type	Pallet dimension
100-121688 *	100 m / 2200 m	12x1,6	75x75 cm
200-121688 *	200 m / 3000 m	12x1,6	75x75 cm
100-140210	100 m / 2200 m	14x2	75x75 cm
200-140210	200 m / 3000 m	14x2	80x80 cm
50-160212	50 m / 1500 m	16x2	120x80 cm
100-160212	100 m / 2200 m	16x2	75x75 cm
200-160212	200 m / 2600 m	16x2	75x75 cm
500-160212D	500 m / 2500 m	16x2	80x80 cm
100-180214	100 m / 1700 m	18x2	75x75 cm
200-180214	200 m / 2000 m	18x2	75x75 cm
25-200216	25 m / 800 m	20x2	120x80 cm
50-200216	50 m / 1000 m	20x2	120x80 cm
100-200216	100 m / 1500 m	20x2	75x75 cm
50-260320	50 m / 800 m	26x3	75x75 cm
50-320326	50 m / 650 m	32x3	90x90 cm

* 6 bar - 60°C

Type: COIL CSC



Henco multilayer pipe (Coil Small Core)
 Henco meerlagenbuis (Rol Kleine Kern)
 Henco tube multicouche (Petit Rouleau Noyau intérieure)
 Henco Mehrschichtverbundrohr (Ring kleinen Kern)

Article number	Pallet	Type	Pallet dimension
10-160212-KB	10 m / 800 m	16x2	120x80 cm
15-160212-KB	15 m / 900 m	16x2	120x80 cm
25-160212-KB*	25 m / 1125 m	16x2	120x80 cm
25-200216-KB	25 m / 900 m	20x2	120x80 cm

ID Coil: 28cm

*TILL EXHAUSTION OF STOCK



A. STANDARD (PE-Xc/AL/PE-Xc)

1 Type: STRAIGHT LENGTH



Henco multilayer pipe (Straight length)

Henco meerlagenbuis (Stang)

Henco tube multicouche (Barre)

Henco Mehrschichtverbundrohr (Stange)

Article number	Cylinder / Pallet	Type	Pallet dimension
03-160212	75 m / 3600 m	16x2	310x70,5cm
04-160212	100 m / 4800 m	16x2	410x70,5 cm
05-160212	125 m / 6000 m	16x2	510x70,5 cm
03-180214	60 m 2880 m	18x2	310x70,5 cm
05-180214	100 m / 4800 m	18x2	510x70,5 cm
03-200216	54 m / 2592 m	20x2	310x70,5 cm
04-200216	72 m / 3456 m	20x2	410x70,5 cm
05-200216	90 m / 4320 m	20x2	510x70,5 cm
03-260320	30 m / 1440 m	26x3	310x70,5 cm
04-260320	40 m / 1920 m	26x3	410x70,5 cm
05-260320	50 m / 2400 m	26x3	510x70,5 cm
03-320326	21 m /1008 m	32x3	310x70,5 cm
04-320326	28 m / 1344 m	32x3	410x70,5 cm
05-320326	35 m / 1680 m	32x3	510x70,5cm
03-403533	27 m / 648 m	40x3,5	310x70,5 cm
04-403533	36 m / 864 m	40x3,5	410x70,5 cm
05-403533	45 m / 1080 m	40x3,5	510x70,5 cm
03-504042	21 m / 504 m	50x4	310x70,5 cm
04-504042	28 m / 672 m	50x4	410x70,5 cm
05-504042	35 m / 840 m	50x4	510x70,5 cm
03-634554	12 m /288 m	63x4,5	310x70,5 cm
04-634554	16 m / 384 m	63x4,5	410x70,5 cm
05-634554	20 m / 480 m	63x4,5	510x70,5 cm
05-756063	10 m / 240 m	75x6	510x70,5 cm
05-907076	5 m / 240 m	90x7	510x70,5 cm

Type: ISO4 (6 mm)



Pre-insulated (Coil)

Voorgeïsoleerd (Rol)

Pré-isolé (Rouleau)

Isoliert (Ring)

Article number	m / Pallet	Type	Pallet dimension
100-ISO4-14-RO	100 m / 1000 m	14x2 red	75x75 cm
100-ISO4-14-BL	100 m / 1000 m	14x2 blue	75x75 cm
50-ISO4-16-RO	50 m / 700 m	16x2 red	75x75 cm
50-ISO4-16-BL	50 m / 700 m	16x2 blue	75x75 cm
100-ISO4-16-RO	100 m / 1300 m	16x2 red	75x75 cm
100-ISO4-16-BL	100 m / 1300 m	16x2 blue	75x75 cm
50-ISO4-18-RO	50 m / 650 m	18x2 red	75x75 cm
50-ISO4-18-BL	50 m / 650 m	18x2 blue	75x75 cm
50-ISO4-20-RO	50 m / 700 m	20x2 red	75x75 cm
50-ISO4-20-BL	50 m / 700 m	20x2 blue	75x75 cm
100-ISO4-20-RO	100 m / 700 m	20x2 red	75x75 cm
100-ISO4-20-BL	100 m / 700 m	20x2 blue	75x75 cm
25-ISO4-26-RO	25 m / 300 m	26x3 red	75x75 cm
25-ISO4-26-BL	25 m / 300 m	26x3 blue	75x75 cm
50-ISO4-26-RO	50 m / 500 m	26x3 red	75x75 cm
50-ISO4-26-BL	50 m / 500 m	26x3 blue	75x75 cm
25-ISO4-32-RO	25 m / 300 m	32x3 red	75x75 cm
25-ISO4-32-BL	25 m / 300 m	32x3 blue	75x75 cm

A. STANDARD (PE-Xc/AL/PE-Xc)



Type: ISO9 (10 mm)



Pre-insulated (Coil)
Voorgeïsoleerd (Rol)
Pré-isolé (Rouleau)
Isoliert (Ring)

Article number	m / Pallet	Type	Pallet dimension
50-ISO9-14-RO	50 m / 550 m	14x2 red	75x75 cm
50-ISO9-14-BL	50 m / 550 m	14x2 blue	75x75 cm
50-ISO9-16-RO	50 m / 550 m	16x2 red	75x75 cm
50-ISO9-16-BL	50 m / 550 m	16x2 blue	75x75 cm
50-ISO9-18-RO	50 m / 500 m	18x2 red	75x75 cm
50-ISO9-18-BL	50 m / 500 m	18x2 blue	75x75 cm
50-ISO9-20-RO	50 m / 500 m	20x2 red	75x75 cm
50-ISO9-20-BL	50 m / 500 m	20x2 blue	75x75 cm
25-ISO9-26-RO	25 m / 275 m	26x3 red	75x75 cm
25-ISO9-26-BL	25 m / 275 m	26x3 blue	75x75 cm
50-ISO9-26-RO	50 m / 450 m	26x3 red	75x75 cm
50-ISO9-26-BL	50 m / 450 m	26x3 blue	75x75 cm
25-ISO9-32-RO	25 m / 250 m	32x3 red	75x75 cm
25-ISO9-32-BL	25 m / 250 m	32x3 blue	75x75 cm

Type: ISO13 (13 mm)



Pre-insulated (Coil)
Voorgeïsoleerd (Rol)
Pré-isolé (Rouleau)
Isoliert (Ring)

Article number	m / Pallet	Type	Pallet dimension
50-ISO13-16-BL	50 m / 400 m	16x2 blue	75x75 cm
50-ISO13-18-BL	50 m / 400 m	18x2 blue	75x75 cm
50-ISO13-20-BL	50 m / 400 m	20x2 blue	75x75 cm
50-ISO13-26-BL	50 m / 400 m	26x3 blue	75x75 cm
25-ISO13-32-BL	25 m / 200 m	32x3 blue	75x75 cm



A. STANDARD (PE-Xc/AL/PE-Xc)

1 Type: COMBI ISO



Henco Combi iso 6 mm (Coil)
 Henco Combi iso 6mm (Rol)
 Henco Combi iso 6mm (Rouleau)
 Henco Combi iso 6mm (Ring)

Article number	m / Pallet	Type	Pallet dimension
50-ISO4-COMBI16	50 m / 400 m	16x2	80x80 cm

8 Type: STANDARD PIPE IN PIPE



With colour coded conduit (Coil)
 Met mantel (Rol)
 Avec gaine (Rouleau)
 Mit Mantel (Ring)

Article number	m / Pallet	Type	Pallet dimension
25-014MR	25 m / 500 m	14x2 red	120x80 cm
25-014MB	25 m / 500 m	14x2 blue	120x80 cm
50-014MR	50 m / 800 m	14x2 red	120x80 cm
50-014MB	50 m / 800 m	14x2 blue	120x80 cm
50-014MBLACK	50 m / 800 m	14x2 black	120x80 cm
100-014MR	100 m / 1000 m	14x2 red	120x80 cm
100-014MB	100 m / 1000 m	14x2 blue	120x80 cm
100-014MBLACK	100 m / 1000 m	14x2 black	120x80 cm
25-016MR	25 m / 500 m	16x2 red	120x80 cm
25-016MB	25 m / 500 m	16x2 blue	120x80 cm
50-016MR	50 m / 800 m	16x2 red	120x80 cm
50-016MB	50 m / 800 m	16x2 blue	120x80 cm
50-016MBLACK	50 m / 800 m	16x2 black	120x80 cm
100-016MR	100 m / 1000 m	16x2 red	120x80 cm
100-016MB	100 m / 1000 m	16x2 blue	120x80 cm
100-016MBLACK	100 m / 1000 m	16x2 black	120x80 cm
50-018MR	50 m / 800 m	18x2 red	120x80 cm
50-018MB	50 m / 800 m	18x2 blue	120x80 cm
100-018MR	100 m / 1000 m	18x2 red	120x80 cm
100-018MB	100 m / 1000 m	18x2 blue	120x80 cm
25-020MR	25 m / 500 m	20x2 red	120x80 cm
25-020MB	25 m / 500 m	20x2 blue	120x80 cm
25-020MBLACK	25 m / 500 m	20x2 black	120x80 cm
50-020MR	50 m / 800 m	20x2 red	120x80 cm
50-020MB	50 m / 800 m	20x2 blue	120x80 cm
50-020MBLACK	50 m / 800 m	20x2 black	120x80 cm
100-020MB	100 m / 1000 m	20x2 blue	120x80 cm
100-020MR	100 m / 1000 m	20x2 red	120x80 cm
25-026MR	25 m / 500 m	26x3 red	120x80 cm
25-026MB	25 m / 500 m	26x3 blue	120x80 cm
50-026MR	50 m / 500 m	26x3 red	120x80 cm
50-026MB	50 m / 500 m	26x3 blue	120x80 cm
50-026MBLACK	50 m / 500 m	26x3 black	120x80 cm
25-032MR	25 m / 300 m	32x3 red	120x80 cm
25-032MB	25 m / 300 m	32x3 blue	120x80 cm

A. STANDARD (PE-Xc/AL/PE-Xc)



Type: COMBI STANDARD



Henco Combi (Coil)
Henco Combi (Rol)
Henco Combi (Rouleau)
Henco Combi (Ring)

Article number	m / Pallet	Type	Pallet dimension
50-COMBI16	50 m / 800 m	16x2	120x80 cm

Type: FLEX STANDARD



Henco Flex (Coil)
Henco Flex (Rol)
Henco Flex (Rouleau)
Henco Flex (Ring)

Article number	Packing	Type
100-FLEX26	100 m	2 - 26x3 (OD90)
100-FLEX32	100 m	2 - 32x3 (OD125)

TILL EXHAUSTION OF STOCK

1

2

3

4

5

6

7

8

9

10

11



A. STANDARD (PE-Xc/AL/PE-Xc)

1

Type: STANDARD PIPE IN PIPE CSC



With colour coded conduit (Coil Small Core)

Met mantel (Rol Kleine Kern)

Avec gaine (Petit Rouleau Noyau intérieure)

Mit Mantel (Ring kleinen Kern)

Article number	Pallet	Type	Pallet dimension
25-016MB-KB	25 m / 600 m	16x2	120x80 cm
25-016MR-KB	25 m / 600 m	16x2	120x80 cm

ID Coil: 28cm

2

3

4

5

6

7

8

9

Type: LB



Henco carcassing pipe Ø 16

Dubbele radiatorbocht Henco buis Ø 16, doorverbonden einde

Double courbe radiateur, tube Henco Ø 16, embout fermé

Heizkörperwinkel doppelt, Henco Rohr Ø 16, durchgestellt Ende

Article number	m	Type
LB50	1 m	50 mm

10

11



Type: ISO-BLOCK-S

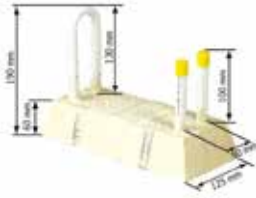

Henco carcassing pipe Ø 16 with insulation
 Dubbele radiator aansluitbocht met isolatie, Ø 16, doorverbonden einde
 Double courbe radiateur, Ø 16, avec isolation, embout fermé
 Heizkörperwinkel doppelt mit Isolation, Ø 16, durchgestellt Ende

Article number	m	Type
ISO-BLOCK-S	1 m	ISO-BLOCK-S

Type: ISO-BLOCK-XL



Henco carcassing pipe Ø 16 with insulation
 Dubbele radiator aansluitbocht met isolatie, Ø 16, doorverbonden einde
 Double courbe radiateur, Ø 16, avec isolation, embout fermé
 Heizkörperwinkel doppelt mit Isolation, Ø 16, durchgestellt Ende

Article number	m	Type
ISO-BLOCK-XL	1 m	ISO-BLOCK-XL

TILL EXHAUSTION OF STOCK

- 1
- 2
- 3
- 4
- 5
- 6
- 7
- 8
- 9
- 10
- 11



B. RIXc (PE-Xc/AL/PE-Xc)

1 Type: COIL



Henco multilayer pipe RIXc (Coil)
 Henco meerlagenbuis RIXc (Rol)
 Henco tube multicouche RIXc (Rouleau)
 Henco Merschichtverbundrohr RIXc (Ring)

Article number	m / Pallet	Type	Pallet dimension
50-R160212	50 m / 1500 m	16x2	160x80 cm
100-R160212	100 m / 2200 m	16x2	75x75 cm
200-R160212	200 m / 2600 m	16x2	75x75 cm
500-R160212D	500 m / 2500 m	16x2	75x75 cm
100-R180214	100 m / 1700 m	18x2	75x75 cm
200-R180214	200 m / 2000 m	18x2	75x75 cm
100-R200216	100 m / 1500 m	20x2	75x75 cm
50-R260320	50 m / 800 m	26x3	75x75 cm

2 Type: COIL CSC



Henco multilayer pipe RIXc (Coil Small Core)
 Henco meerlagenbuis RIXc (Rol Kleine Kern)
 Henco tube multicouche RIXc (Rouleau Petit Noyau)
 Henco Merschichtverbundrohr RIXc (Ring kleinen Kern)

Article number	Pallet	Type	Pallet dimension
10-R160212-KB	10 m / 800 m	16x2	120x80 cm
15-R160212-KB	15 m / 900 m	16x2	120x80 cm
25-R160212-KB	25 m / 1125 m	16x2	120x80 cm

ID Coil: 28cm

3 Type: STRAIGHT LENGTH



Henco multilayer pipe RIXc (Straight length)
 Henco meerlagenbuis RIXc (Stang)
 Henco tube multicouche RIXc (Barre)
 Henco Merschichtverbundrohr RIXc (Stange)

Article number	Cylinder	Type	Pallet dimension
03-R160212	75 m / 3600 m	16x2	310x75 cm
04-R160212	100 m / 4800 m	16x2	410x75 cm
05-R160212	125 m / 6000 m	16x2	510x75 cm
03-R200216	54 m / 2592 m	20x2	310x75 cm
04-R200216	72 m / 3456 m	20x2	410x75 cm
05-R200216	90 m / 4320 m	20x2	510x75 cm
03-R260320	30 m / 1440 m	26x3	310x75 cm
04-R260320	40 m / 1920 m	26x3	410x75 cm
05-R260320	50 m / 2400 m	26x3	510x75 cm

B. RIXc (PE-Xc/AL/PE-Xc)



Type: ISO4 (6 mm)



RIXc Pre-insulated (Coil)
 RIXc Voorgeïsoleerd (Rol)
 RIXc Pré-isolé (Rouleau)
 RIXc Isoliert (Ring)

Article number	m / Pallet	Typ	Pallet dimension
100-ISO4-R16-RO	100 m / 1300 m	16x2 red	75x75 cm
100-ISO4-R16-BL	100 m / 1300 m	16x2 blue	75x75 cm
50-ISO4-R16-RO	50 m / 700 m	16x2 red	75x75 cm
50-ISO4-R16-BL	50 m / 700 m	16x2 blue	75x75 cm
50-ISO4-R18-RO	50 m / 650 m	18x2 red	75x75 cm
50-ISO4-R18-BL	50 m / 650 m	18x2 blue	75x75 cm
50-ISO4-R20-RO	50 m / 700 m	20x2 red	75x75 cm
50-ISO4-R20-BL	50 m / 700 m	20x2 blue	75x75 cm
25-ISO4-R26-RO	25 m / 300 m	26x3 red	75x75 cm
25-ISO4-R26-BL	25 m / 300 m	26x3 blue	75x75 cm
50-ISO4-R26-RO	50 m / 500 m	26x3 red	75x75 cm
50-ISO4-R26-BL	50 m / 500 m	26x3 blue	75x75 cm

Type: ISO9 (10 mm)



RIXc Pre-insulated (Coil)
 RIXc Voorgeïsoleerd (Rol)
 RIXc Pré-isolé (Rouleau)
 RIXc Isoliert (Ring)

Article number	m / Pallet	Typ	Pallet dimension
50-ISO9-R16-RO	50 m / 550 m	16x2 red	75x75 cm
50-ISO9-R16-BL	50 m / 550 m	16x2 blue	75x75 cm
50-ISO9-R18-BL	50 m / 650 m	18x2 blue	75x75 cm
50-ISO9-R20-RO	50 m / 500 m	20x2 red	75x75 cm
50-ISO9-R20-BL	50 m / 500 m	20x2 blue	75x75 cm
25-ISO9-R26-RO	25 m / 275 m	26x3 red	75x75 cm
25-ISO9-R26-BL	25 m / 275 m	26x3 blue	75x75 cm

Type: ISO13 (13 mm)



RIXc Pre-insulated (Coil)
 RIXc Voorgeïsoleerd (Rol)
 RIXc Pré-isolé (Rouleau)
 RIXc Isoliert (Ring)

Article number	m / Pallet	Typ	Pallet dimension
50-ISO13-R16-BL	50 m / 500 m	16x2 blue	75x75 cm
50-ISO13-R20-BL	50 m / 400 m	20x2 blue	75x75 cm
50-ISO13-R26-BL	50 m / 400 m	26x3 blue	75x75 cm



B. RIXc (PE-Xc/AL/PE-Xc)

1 Type: COMBI ISO RIXc



Henco Combi iso 6 mm (Coil)
 Henco Combi iso 6mm (Rol)
 Henco Combi iso 6mm (Rouleau)
 Henco Combi iso 6mm (Ring)

Article number	m / Pallet	Type	Pallet dimension
50-ISO4-COMBI16R	50 m / 400 m	16x2	75x75 cm

8 Type: RIXc PIPE IN PIPE



RIXc With colour coded conduit (Coil)
 RIXc Met mantel (Rol)
 RIXc Avec gaine (Rouleau)
 RIXc Mit Mantel (Ring)

Article number	m / Pallet	Type	Pallet dimension
25-R16MR	25 m / 500 m	16x2 red	120x80 cm
25-R16MB	25 m / 500 m	16x2 blue	120x80 cm
50-R16MR	50 m / 1000 m	16x2 red	120x80 cm
50-R16MB	50 m / 1000 m	16x2 blue	120x80 cm
50-R16MBLACK	50 m / 1000 m	16x2 black	120x80 cm
100-R16MR	100 m / 1000 m	16x2 red	120x80 cm
100-R16MB	100 m / 1000 m	16x2 blue	120x80 cm
100-R16MBLACK	100 m / 1000 m	16x2 black	120x80 cm
50-R18MR	50 m / 800 m	18x2 red	120x80 cm
50-R18MB	50 m / 800 m	18x2 blue	120x80 cm
25-R20MR	25 m / 500 m	20x2 red	120x80 cm
25-R20MB	25 m / 500 m	20x2 blue	120x80 cm
25-R20MBLACK	25 m / 500 m	20x2 black	120x80 cm
50-R20MR	50 m / 800 m	20x2 red	120x80 cm
50-R20MB	50 m / 800 m	20x2 blue	120x80 cm
100-R20MR	100 m / 1000 m	20x2 red	120x80 cm
100-R20MB	100 m / 1000 m	20x2 blue	120x80 cm
50-R26MR	50 m / 500 m	26x3 red	120x80 cm
50-R26MB	50 m / 500 m	26x3 blue	120x80 cm

Type: COMBI RIXc



Henco Combi (Coil)
 Henco Combi (Rol)
 Henco Combi (Rouleau)
 Henco Combi (Ring)

Article number	m / Pallet	Type	Pallet dimension
50-COMBI16R	50 m / 800 m	16x2	120x80 cm



Type: FLOOR-RIXc



Henco multilayer pipe (Coil)
Henco meerlagenbuis (Rol)
Henco tube multicouche (Rouleau)
Henco Mehrschichtverbundrohr (Ring)

Article number	m / Pallet	Type	Pallet dimension
100-F16R-WZ	100 m / 2200 m	16x2	75x75 cm
200-F16R-WZ	200 m / 2600 m	16x2	80x80 cm
500-F16R-WZ	500 m / 2500 m	16x2	75x75 cm
100-F20R-WZ	100 m / 1000 m	20x2	75x75 cm
200-F20R-WZ	200 m / 1000 m	20x2	75x75 cm
400-F20R-WZ	400 m / 1200 m	20x2	75x75 cm

6 bar - 60°C

1

2

3

4

5

6

7

8

9

10

11



D. PE-Xc

1

Type: 5L PE-Xc

2

3

4

5

6

7

8

9

10

11



Henco 5L PE-Xc pipe PE-Xc/EVOH/PE-Xc (Coil)

Henco 5L PE-Xc buis PE-Xc/EVOH/PE-Xc (Rol)

Henco 5L PE-Xc tube PE-Xc/EVOH/PE-Xc (Rouleau)

Henco 5L PE-Xc Rohr PE-Xc/EVOH/PE-Xc (Ring)

Article number	m / Pallet	Type	Pallet dimension
200-PXC1620	200 m / 1600 m	16x2	75x75 cm
600-PXC1620	600 m / 2400 m	16x2	80x80 cm
200-PXC1720	200 m / 2000 m	17x2	80x80 cm
600-PXC1720	600 m / 2400 m	17x2	80x80 cm
240-PXC1820	240 m / 2160 m	18x2	80x80 cm
200-PXC2020	200 m / 1000 m	20x2	75x75 cm
600-PXC2020	600 m / 1200 m	20x2	



Type: 5L PE-RT



Henco 5L PE-RT pipe PE-RT/EVOH/PE-RT (Coil)

Henco 5L PE-RT buis PE-RT/EVOH/PE-RT (Rol)

Henco 5L PE-RT tube PE-RT/EVOH/PE-RT (Rouleau)

Henco 5L PE-RT Rohr PE-RT/EVOH/PE-RT (Ring)

Article number	m / Pallet	Type	Pallet dimension
120-PRT1620	120 m / 1440 m	16x2	80x80 cm
200-PRT1620	200 m / 1600 m	16x2	80x80 cm
200-PRT1820	200 m / 2000 m	18x2	80x80 cm
600-PRT1620	600 m / 2400 m	16x2	80x80 cm
600-PRT1720	600 m / 2400 m	17x2	80x80 cm
600-PRT1820	600 m / 1200 m	18x2	80x80 cm
600-PRT2020	600 m / 1800 m	20x2	80x80 cm

1

2

3

4

5

6

7

8

9

10

11



F. PROTECTION HOSE

1 Type: PROTECTION HOSE



Colour coded conduit (Coil)

Mantel (Rol)

Gaine (Rouleau)

Mantel (Ring)

Article number	m / Pallet	Type	Pallet dimension
100-MR	100 m / 2400 m	Ø14/Ø16/Ø18	120x80 cm
100-MB	100 m / 2400 m	Ø14/Ø16/Ø18 blue	120x80 cm
50-MR20	50 m / 1800 m	Ø20 red	120x80 cm
50-MB20	50 m / 1800 m	Ø20 blue	120x80 cm
50-MR26	50 m / 1200 m	Ø26 red	120x80 cm
50-MB26	50 m / 1200 m	Ø26 blue	120x80 cm
25-MR32	25 m / 1000 m	Ø32 red	120x80 cm
25-MB32	25 m / 1000 m	Ø32 blue	120x80 cm
100-MBLACK	100 m / 2400 m	Ø14/Ø16/Ø18 black	120x80 cm
50-MBLACK20	50 m / 1800 m	Ø20 black	120x80 cm
50-MBLACK26	50 m / 1200 m	Ø26 black	120x80 cm

11 Type: PROTECTION HOSE GAS



Colour coded conduit (Coil)

Mantel (Rol)

Gaine (Rouleau)

Mantel (Ring)

Article number	m / Pallet	Type	Pallet dimension
50-MG16	50 m / 2400 m	Ø16 yellow	120x80 cm
100-MG16	100 m / 2400 m	Ø16 yellow	120x80 cm
50-MG20	50 m / 1800 m	Ø20 yellow	120x80 cm
50-MG26	50 m / 1200 m	Ø26 yellow	120x80 cm
25-MG32	25 m / 1000 m	Ø32 yellow	120x80 cm

G. GAS STANDARD (PE-Xc/AL/PE-Xc)



Gas: only allowed in countries where has been a HENCO GAS testing + certificate is available! (see www.henco.be)
 Gas: enkel toegelaten in landen waar er een HENCO GAS keur is + een certificaat voorhanden is! (zie www.henco.be)
 Gaz: seulement permis dans des pays où le contrôle a eu lieu + certificat est disponible! (Consultez www.henco.be)
 Gas: nur zugelassen in Länder wo HENCO GAS Prüfung geschehen ist + Zertifikat vorhanden ist! (Siehe www.henco.be)

Type: COIL



Henco multilayer pipe (Coil)
 Henco Meerlagenbuis (Rol)
 Henco tube multicouche (Rouleau)
 Henco Mehrschichtverbundrohr (Ring)

Article number	m / Pallet	Type	Pallet dimension
25-160212-GAS*	25 m / 800 m	16x2	75x75 cm
50-160212-GAS	50 m / 1500 m	16x2	120x80 cm
25-200216-GAS	25 m / 800 m	20x2	75x75 cm
50-200216-GAS	50 m / 1000 m	20x2	120x80 cm
50-260320-GAS	50 m / 800 m	26x3	75x75 cm
50-320326-GAS	50 m / 650 m	32x3	90x90 cm

*TILL EXHAUSTION OF STOCK

Type: STRAIGHT LENGTH



Henco multilayer pipe (Straight length)
 Henco Meerlagenbuis (Stang)
 Henco tube multicouche (Barre)
 Henco Mehrschichtverbundrohr (Stange)

Article number	Cylinder / Pallet	Type	Pallet dimension
05-160212-GAS	125 m / 6000 m	16x2	510x70,5 cm
05-200216-GAS	90 m / 4300 m	20x2	510x70,5 cm
05-260320-GAS	50 m / 2400 m	26x3	510x70,5 cm
05-320326-GAS	35 m / 1680 m	32x3	510x70,5 cm
05-403533-GAS	45 m / 1080 m	40x3,5	510x70,5 cm

Type: GAS PIPE IN PIPE



With colour coded conduit (Coil)
 Met mantel (Rol)
 Avec gaine (Rouleau)
 Mit Mantel (Ring)

Article number	m / Pallet	Typ	Pallet dimension
25-016GASMG	25 m / 500 m	16x2	120x80 cm
50-016GASMG	50 m / 500 m	16x2	120x80 cm
25-020GASMG	25 m / 500 m	20x2	120x80 cm
50-020GASMG	50 m / 800 m	20x2	120x80 cm
50-026GASMG	50 m / 500 m	26x3	120x80 cm
25-032GASMG	25 m / 300 m	32x3	120x80 cm

Gastec: Standard pipe gas in combination with Henco press fittings PVDF for gas, see page 43

DVGW and Kiwa Uni: Standard pipe gas in combination with Henco brass press fittings for gas, see page 85



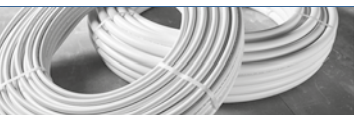

H. SPRINKLER

1

Sprinkler: only allowed in countries where a HENCO Sprinkler certificate is available! (see www.henco.be)

Sprinkler: enkel toegelaten in landen waar een HENCO Sprinkler certificaat voorhanden is! (zie www.henco.be)

Sprinkler: seulement permis dans des pays où le HENCO Sprinkler certificat est disponible! (consultez www.henco.be)

Sprinkler: nur zugelassen in Länder wo HENCO Sprinkler Zertifikat vorhanden ist! (siehe www.henco.be)

2

3

4

5

6

7

8

9

10

11

Type: COIL



Henco multilayer pipe (Coil)

Henco Meerlagenbuis (Rol)

Henco tube multicouche (Rouleau)

Henco Mehrschichtverbundrohr (Ring)

Article number	m / Pallet	Type	Pallet dimension
50-260320-SPR	30 m / 1440 m	26 x 3	310x70,5 cm
50-320326-SPR	40 m / 1920 m	32 x 3	410x70,5 cm

Type: Straight length



Henco multilayer pipe (Straight length)

Henco meerlagenbuis (stang)

Henco tube multicouche (Barre)

Hanco Merhschichtverbundrohr (Stange)

Article number	m / Pallet	Type	Pallet dimension
05-260320-SPR	50 m / 2400 m	26 x 3	510x70,5 cm
05-320326-SPR	35 m / 1680 m	32 x 3	510x70,5 cm
05-403533-SPR	45 m / 1080 m	40 x 3,5	510x70,5 cm
05-504042-SPR	35 m / 840 m	50 x 4	510x70,5 cm
05-634554-SPR	20 m / 480 m	63 x 4,5	510x70,5 cm

Standard pipe Sprinkler in combination with Henco press fittings PVDF for Sprinkler, see page 47

Sprinkler Cup: see page 52





	<i>Page</i>
A. PK	22
B. PKW	35
C. PKG	42
D. PKS	47
E. SUPER SIZES	53
F. ECOLINE	59



A. PK

Type: 1PK



Elbow 90°

Knie 90°

Coude 90°

Winkel 90°

Article number	Bag / Box	Type
1PK-1414	10 pc. / 150 pc.	14x14
1PK-1616	10 pc. / 120 pc.	16x16
1PK-1818	10 pc. / 100 pc.	18x18
1PK-2020	10 pc. / 80 pc.	20x20
1PK-2626	5 pc. / 50 pc.	26x26
1PK-3232	5 pc. / 30 pc.	32x32
1PK-4040	5 pc. / 20 pc.	40x40
1PK-5050	1 pc. / 8 pc.	50x50
1PK-6363	1 pc. / 6 pc.	63X63
1PK-7575	1 pc. / 1 pc.	75x75
1PK-9090	1 pc. / 1 pc.	90x90

Type: 1PK-JG



Elbow 90° 16x10JG (ceiling cooling)

Knie 90° 16x10JG (koelplafond)

Coude 90° 16x10JG (plafond climatisé)

Winkel 90° 16x10JG (Klimaatplafond)

Article number	Bag / Box	Type
1PK-16JG10	10 pc. / 120 pc.	16x10JG
1PK-20JG10	10 pc. / 100 pc.	20x10JG

Type: 2PK



Backplate elbow female

Sanitair muurplaat binnendraad

Culasse pour sanitaire

Sanitär Wandscheibe IG

Article number	Bag / Box	Type
2PK-1404BP*	10 pc. / 50 pc.	14x1/2" (56 mm)
2PK-1603	10 pc. / 50 pc.	16x3/8" (56 mm)
2PK-1604BP*	10 pc. / 50 pc.	16x1/2" (56 mm)
2PK-1804BP*	10 pc. / 50 pc.	18x1/2" (56 mm)
2PK-2004BP*	10 pc. / 50 pc.	20x1/2" (56 mm)
2PK-2005	5 pc. / 30 pc.	20x3/4" (56 mm)
2PK-2605	5 pc. / 30 pc.	26x3/4" (56 mm)

* With black plug BP04 1/2"

Accessory 2PK: galvanised bracket plate - see page 168



PLP-P-PK



PLF-P-PK



Type: 2PK-K



Backplate elbow female, short model
Sanitair muurplaat binnendraad, laag
Culasse pour sanitaire, modèle court
Sanitär Wandscheibe IG, kurzes Modell

Article number	Bag / Box	Type
2PK-1604KBP*	10 pc. / 50 pc.	16x1/2" (40 mm)

** With black plug BP04 1/2"*

Accessory 2PK-K: galvanised bracket plate - see page 168



PLP-P-PK



PLF-P-PK

Type: 3PK



Double backplate elbow female, short model
Sanitair muurplaat binnendraad dubbel, laag
Culasse double pour sanitaire, modèle court
Sanitär Wandscheibe doppelt IG, kurzes Modell

Article number	Bag / Box	Type
3PK-160416BP*	10 pc. / 30 pc.	16x1/2"x16 (40 mm)
3PK-200420BP*	10 pc. / 30 pc.	20x1/2"x20 (40 mm)

** With black plug BP04 1/2"*

Type: BP04



Black plug for 1/2" female nipple
Zwarte stop voor 1/2"
Bouchon noir pour 1/2" nipple femelle
Schwarzen Stopf für 1/2" Nippel

Article number	Bag / Box	Type
BP04	50 pc. / 500 pc.	1/2"

- 1
- 2
- 3
- 4
- 5
- 6
- 7
- 8
- 9
- 10
- 11



A. PK

Type: 5PK (CW617)



PK-TOOL p 170

Bend 90° male adapter

Knie 90° buitendraad

Coude 90° mâle

Winkel 90° AG

Article number	Bag / Box	Type
5PK-1404	10 pc. / 60 pc.	14x1/2"
5PK-1604	10 pc. / 60 pc.	16x1/2"
5PK-1804	10 pc. / 60 pc.	18x1/2"
5PK-2004	10 pc. / 60 pc.	20x1/2"
5PK-2005	10 pc. / 50 pc.	20x3/4"
5PK-2605	10 pc. / 40 pc.	26x3/4"
5PK-3206	5 pc. / 20 pc.	32x1"
5PK-4007	3 pc. / 15 pc.	40x1 1/4"
5PK-5007	1 pc. / 10 pc.	50x1 1/4"
5PK-5008	1 pc. / 8 pc.	50x1 1/2"
5PK-6310	1 pc. / 4 pc.	63x2"
5PK-7510	1 pc. / 1 pc.	75x2"
5PK-7512	1 pc. / 1 pc.	75x2 1/2"

Type: 5PK-N (CW602)



PK-TOOL p 170

Bend 90° male adapter

Knie 90° buitendraad

Coude 90° mâle

Winkel 90° AG

Article number	Bag / Box	Type
5PK-4007-N	3 pc. / 15 pc.	40x1 1/4"
5PK-5007-N	1 pc. / 10 pc.	50x1 1/4"
5PK-5008-N	1 pc. / 8 pc.	50x1 1/2"
5PK-6310-N	1 pc. / 4 pc.	63x2"

Type: 6PK (CW617)



PK-TOOL p 170

Bend 90° female adapter

Knie 90° binnendraad

Coude 90° femelle

Winkel 90° IG

Article number	Bag / Box	Type
6PK-1404BP*	10 pc. / 60 pc.	14x1/2"
6PK-1603	10 pc. / 60 pc.	16x3/8"
6PK-1604BP*	10 pc. / 60 pc.	16x1/2"
6PK-1804BP*	10 pc. / 60 pc.	18x1/2"
6PK-2004BP*	10 pc. / 60 pc.	20x1/2"
6PK-2005	10 pc. / 50 pc.	20x3/4"
6PK-2605	10 pc. / 50 pc.	26x3/4"
6PK-3206	5 pc. / 20 pc.	32x1"
6PK-4007	5 pc. / 15 pc.	40x1 1/4"
6PK-5007	1 pc. / 8 pc.	50x1 1/4"
6PK-5008	1 pc. / 8 pc.	50x1 1/2"
6PK-6310	1 pc. / 4 pc.	63x2"
6PK-7506	1 pc. / 1 pc.	75x1"
6PK-7510	1 pc. / 1 pc.	75x2"
6PK-7512	1 pc. / 1 pc.	75x2 1/2"
6PK-9014	1 pc. / 1 pc.	90x3"



Type: 6PK-N (CW602)



PK-TOOL p 170

Bend 90° female adapter
Knie 90° binnendraad
Coude 90° femelle
Winkel 90° IG

Article number	Bag / Box	Type
6PK-4007-N	5 pc. / 15 pc.	40x1 1/4"
6PK-5007-N	1 pc. / 8 pc.	50x1 1/4"
6PK-5008-N	1 pc. / 8 pc.	50x1 1/2"
6PK-6310-N	1 pc. / 4 pc.	63x2"

Type: 9PK



T-piece
T-stuk
Pièce en T
T-Stück

Article number	Bag / Box	Type
9PK-141414	10 pc. / 100 pc.	14x14x14
9PK-161616	10 pc. / 60 pc.	16x16x16
9PK-181818	10 pc. / 60 pc.	18x18x18
9PK-202020	10 pc. / 50 pc.	20x20x20
9PK-262626	5 pc. / 30 pc.	26x26x26
9PK-323232	5 pc. / 15 pc.	32x32x32
9PK-404040	5 pc. / 10 pc.	40x40x40
9PK-505050	1 pc. / 6 pc.	50x50x50
9PK-636363	1 pc. / 3 pc.	63x63x63
9PK-757575	1 pc. / 1 pc.	75x75x75
9PK-909090	1 pc. / 1 pc.	90x90x90

- 1
- 2
- 3
- 4
- 5
- 6
- 7
- 8
- 9
- 10
- 11



A. PK

Type: 10PK



T-reduced centre

T-verlopend

Pièce en T-réduit

T-reduziert

Article number	Bag / Box	Type
10PK-161416	10 pc. / 50 pc.	16x14x16
10PK-181418	10 pc. / 50 pc.	18x14x18
10PK-181618	10 pc. / 50 pc.	18x16x18
10PK-201420	10 pc. / 50 pc.	20x14x20
10PK-201620	10 pc. / 50 pc.	20x16x20
10PK-201820	10 pc. / 50 pc.	20x18x20
10PK-261626	5 pc. / 30 pc.	26x16x26
10PK-261826	5 pc. / 30 pc.	26x18x26
10PK-262026	5 pc. / 30 pc.	26x20x26
10PK-321632	5 pc. / 25 pc.	32x16x32
10PK-321832	5 pc. / 25 pc.	32x18x32
10PK-322032	5 pc. / 25 pc.	32x20x32
10PK-322632	5 pc. / 20 pc.	32x26x32
10PK-401640	5 pc. / 15 pc.	40x16x40
10PK-402040	5 pc. / 15 pc.	40x20x40
10PK-402640	5 pc. / 15 pc.	40x26x40
10PK-403240	5 pc. / 10 pc.	40x32x40
10PK-502050	1 pc. / 6 pc.	50x20x50
10PK-502650	1 pc. / 8 pc.	50x26x50
10PK-503250	1 pc. / 8 pc.	50x32x50
10PK-504050	1 pc. / 6 pc.	50x40x50
10PK-632663	1 pc. / 4 pc.	63x26x63
10PK-633263	1 pc. / 3 pc.	63x32x63
10PK-634063	1 pc. / 3 pc.	63x40x63
10PK-635063	1 pc. / 3 pc.	63x50x63
10PK-753275	1 pc. / 1 pc.	75x32x75
10PK-754075	1 pc. / 1 pc.	75x40x75
10PK-755075	1 pc. / 1 pc.	75x50x75
10PK-756375	1 pc. / 1 pc.	75x63x75
10PK-903290	1 pc. / 1 pc.	90x32x90
10PK-904090	1 pc. / 1 pc.	90x40x90
10PK-905090	1 pc. / 1 pc.	90x50x90
10PK-906390	1 pc. / 1 pc.	90x63x90
10PK-907590	1 pc. / 1 pc.	90x75x90

Type: 10PK-JG



T-reduced centre 16x10JGx16 (ceiling cooling)

T-verlopend 16x10JGx16 (koelplafond)

Pièce en T-réduit 16x10JGx16 (plafond climatisé)

T-reduziert 16x10JGx16 (Klimaatplafond)

Article number	Bag / Box	Type
10PK-16JG1016	10 pc. / 50 pc.	16x10JGx16
10PK-20JG1020	10 pc. / 50 pc.	20x10JGx20



Type: 11PK



T-branch and line reduced

T-2X verlopnd

Pièce en T 2X réduit

T-2X reduziert

Article number	Bag / Box	Type
11PK-161414	10 pc. / 50 pc.	16x14x14
11PK-181616	10 pc. / 50 pc.	18x16x16
11PK-201616	10 pc. / 50 pc.	20x16x16
11PK-201818	10 pc. / 50 pc.	20x18x18
11PK-202016	10 pc. / 50 pc.	20x20x16
11PK-261616	10 pc. / 50 pc.	26x16x16
11PK-261620	5 pc. / 30 pc.	26x16x20
11PK-262016	5 pc. / 30 pc.	26x20x16
11PK-262020	5 pc. / 30 pc.	26x20x20
11PK-262616	5 pc. / 30 pc.	26x26x16
11PK-262620	5 pc. / 30 pc.	26x26x20
11PK-322026	5 pc. / 20 pc.	32x20x26
11PK-322626	5 pc. / 20 pc.	32x26x26
11PK-402032	5 pc. / 15 pc.	40x20x32
11PK-402632	5 pc. / 15 pc.	40x26x32
11PK-403232	5 pc. / 10 pc.	40x32x32
11PK-404026	5 pc. / 10 pc.	40x40x26
11PK-404032	5 pc. / 10 pc.	40x40x32
11PK-502040	1 pc. / 10 pc.	50x20x40
11PK-502640	1 pc. / 10 pc.	50x26x40
11PK-503240	1 pc. / 10 pc.	50x32x40
11PK-504040	1 pc. / 8 pc.	50x40x40
11PK-753232	1 pc. / 1 pc.	75x32x32
11PK-753240	1 pc. / 1 pc.	75x32x40
11PK-753250	1 pc. / 1 pc.	75x32x50
11PK-753263	1 pc. / 1 pc.	75x32x63
11PK-753275	1 pc. / 1 pc.	75x32x75
11PK-754040	1 pc. / 1 pc.	75x40x40
11PK-754050	1 pc. / 1 pc.	75x40x50
11PK-754063	1 pc. / 1 pc.	75x40x63
11PK-755050	1 pc. / 1 pc.	75x50x50
11PK-755063	1 pc. / 1 pc.	75x50x63
11PK-756363	1 pc. / 1 pc.	75x63x63
11PK-903232	1 pc. / 1 pc.	90x32x32
11PK-903240	1 pc. / 1 pc.	90x32x40
11PK-903250	1 pc. / 1 pc.	90x32x50
11PK-903263	1 pc. / 1 pc.	90x32x63
11PK-903275	1 pc. / 1 pc.	90x32x75
11PK-903290	1 pc. / 1 pc.	90x32x90
11PK-904040	1 pc. / 1 pc.	90x40x40
11PK-904050	1 pc. / 1 pc.	90x40x50
11PK-904063	1 pc. / 1 pc.	90x40x63
11PK-904075	1 pc. / 1 pc.	90x40x75
11PK-905050	1 pc. / 1 pc.	90x50x50
11PK-905063	1 pc. / 1 pc.	90x50x63
11PK-905075	1 pc. / 1 pc.	90x50x75
11PK-906363	1 pc. / 1 pc.	90x63x63
11PK-906375	1 pc. / 1 pc.	90x63x75
11PK-907575	1 pc. / 1 pc.	90x75x75

- 1
- 2
- 3
- 4
- 5
- 6
- 7
- 8
- 9
- 10
- 11



Type: 12PK



T-enlarged branch

T-vergroot

Pièce en T agrandi

T-erweitert

Article number	Bag / Box	Type
12PK-161816	10 pc. / 50 pc.	16x18x16
12PK-162016	10 pc. / 50 pc.	16x20x16
12PK-202620	5 pc. / 30 pc.	20x26x20
12PK-263226	5 pc. / 20 pc.	26x32x26
12PK-324032	5 pc. / 15 pc.	32x40x32
12PK-327532	1 pc. / 1 pc.	32x75x32
12PK-329032	1 pc. / 1 pc.	32x90x32
12PK-405040	1 pc. / 8 pc.	40x50x40
12PK-407540	1 pc. / 1 pc.	40x75x40
12PK-507550	1 pc. / 1 pc.	50x75x50
12PK-637563	1 pc. / 1 pc.	63x75x63
12PK-409040	1 pc. / 1 pc.	40x90x40
12PK-509050	1 pc. / 1 pc.	50x90x50
12PK-639063	1 pc. / 1 pc.	63x90x63
12PK-759075	1 pc. / 1 pc.	75x90x75

Type: 13PK (CW617)



PK-TOOL p 170

T-female centre

T-binnendraad

Pièce en T femelle

T-IG

Article number	Bag / Box	Type
13PK-160416BP*	10 pc. / 50 pc.	16x1/2"x16
13PK-180418BP*	10 pc. / 50 pc.	18x1/2"x18
13PK-200420BP*	10 pc. / 50 pc.	20x1/2"x20
13PK-200520	10 pc. / 30 pc.	20x3/4"x20
13PK-260420BP*	5 pc. / 30 pc.	26x1/2"x20
13PK-260426BP*	5 pc. / 30 pc.	26x1/2"x26
13PK-260526	5 pc. / 30 pc.	26x3/4"x26
13PK-320532	5 pc. / 15 pc.	32x3/4"x32
13PK-320632	5 pc. / 10 pc.	32x1"x32
13PK-320732	5 pc. / 10 pc.	32x1 1/4"x32
13PK-400640	5 pc. / 10 pc.	40x1"x40
13PK-400740	5 pc. / 10 pc.	40x1 1/4"x40
13PK-500850	1 pc. / 4 pc.	50x1 1/2"x50
13PK-631063	1 pc. / 2 pc.	63x2"x63
13PK-750675	1 pc. / 1 pc.	75x1"x75
13PK-751075	1 pc. / 1 pc.	75x2"x75
13PK-751275	1 pc. / 1 pc.	75x2 1/2"x75
13PK-901490	1 pc. / 1 pc.	90x3"x90

* With black plug BP04 1/2"



Type: 13PK-N (CW602)



PK-TOOL p 170

T-female centre
T-binnendraad
Pièce en T femelle
T-IG

Article number	Bag / Box	Type
13PK-400640-N	5 pc. / 10 pc.	40x1"x40
13PK-400740-N	5 pc. / 10 pc.	40x1 1/4"x40
13PK-500850-N	1 pc. / 4 pc.	50x1 1/2"x50
13PK-631063-N	1 pc. / 2 pc.	63x2"x63

Type: 14PK (CW617)



PK-TOOL p 170

T-male centre
T-buitendraad
Pièce en T mâle
T-AG

Article number	Bag / Box	Type
14PK-160416	10 pc. / 50 pc.	16x1/2"x16
14PK-180418	10 pc. / 50 pc.	18x1/2"x18
14PK-200420	10 pc. / 40 pc.	20x1/2"x20
14PK-200520	10 pc. / 30 pc.	20x3/4"x20
14PK-260426	5 pc. / 30 pc.	26x1/2"x26
14PK-260526	5 pc. / 25 pc.	26x3/4"x26
14PK-260626	5 pc. / 20 pc.	26x1"x26
14PK-320532	5 pc. / 15 pc.	32x3/4"x32
14PK-400640	5 pc. / 10 pc.	40x1"x40
14PK-400740	5 pc. / 10 pc.	40x1 1/4"x40
14PK-500850	1 pc. / 5 pc.	50x1 1/2"x50
14PK-631063	1 pc. / 2 pc.	63x2"x63
14PK-751075	1 pc. / 1 pc.	75x2"x75
14PK-751275	1 pc. / 1 pc.	75x2 1/2"x75

Type: 14PK-N (CW602)



PK-TOOL p 170

T-male centre
T-buitendraad
Pièce en T mâle
T-AG

Article number	Bag / Box	Type
14PK-400640-N	5 pc. / 10 pc.	40x1"x40
14PK-400740-N	5 pc. / 10 pc.	40x1 1/4"x40
14PK-500850-N	1 pc. / 5 pc.	50x1 1/2"x50
14PK-631063-N	1 pc. / 2 pc.	63x2"x63



A. PK

Type: 15PK



Straight coupling
Doorverbinder recht / perssok
Manchon
Kupplung

Article number	Bag / Box	Type
15PK-1414	10 pc. / 150 pc.	14x14
15PK-1616	10 pc. / 150 pc.	16x16
15PK-1818	10 pc. / 100 pc.	18x18
15PK-2020	10 pc. / 80 pc.	20x20
15PK-2626	5 pc. / 50 pc.	26x26
15PK-3232	5 pc. / 30 pc.	32x32
15PK-4040	5 pc. / 25 pc.	40x40
15PK-5050	1 pc. / 12 pc.	50x50
15PK-6363	1 pc. / 9 pc.	63x63
15PK-7575	1 pc. / 1 pc.	75x75
15PK-9090	1 pc. / 1 pc.	90x90

Type: 16PK



Reducing coupling
Verloopstuk
Réduction
Kupplung-reduziert

Article number	Bag / Box	Type
16PK-1614	10 pc. / 100 pc.	16x14
16PK-1814	10 pc. / 100 pc.	18x14
16PK-1816	10 pc. / 100 pc.	18x16
16PK-2014	10 pc. / 100 pc.	20x14
16PK-2016	10 pc. / 100 pc.	20x16
16PK-2018	10 pc. / 100 pc.	20x18
16PK-2616	5 pc. / 60 pc.	26x16
16PK-2618	5 pc. / 50 pc.	26x18
16PK-2620	5 pc. / 50 pc.	26x20
16PK-3216	5 pc. / 50 pc.	32x16
16PK-3220	5 pc. / 40 pc.	32x20
16PK-3226	5 pc. / 40 pc.	32x26
16PK-4026	5 pc. / 30 pc.	40x26
16PK-4032	5 pc. / 25 pc.	40x32
16PK-5032	1 pc. / 15 pc.	50x32
16PK-5040	1 pc. / 15 pc.	50x40
16PK-6340	1 pc. / 8 pc.	63x40
16PK-6350	1 pc. / 8 pc.	63x50
16PK-7532	1 pc. / 1 pc.	75x32
16PK-7540	1 pc. / 1 pc.	75x40
16PK-7550	1 pc. / 1 pc.	75x50
16PK-7563	1 pc. / 1 pc.	75x63
16PK-9032	1 pc. / 1 pc.	90x32
16PK-9040	1 pc. / 1 pc.	90x40
16PK-9050	1 pc. / 1 pc.	90x50
16PK-9063	1 pc. / 1 pc.	90x63
16PK-9075	1 pc. / 1 pc.	90x75



Type: 17PK (CW617)



PK-TOOL p 170

Straight male adapter
Recht aansluitstuk buitendraad / Puntstuk
Raccord droit mâle
Übergangsfitting AG

Article number	Bag / Box	Type
17PK-1404	10 pc. / 80 pc.	14x1/2"
17PK-1604	10 pc. / 80 pc.	16x1/2"
17PK-1804	10 pc. / 80 pc.	18x1/2"
17PK-1805	10 pc. / 50 pc.	18x3/4"
17PK-2004	10 pc. / 80 pc.	20x1/2"
17PK-2005	10 pc. / 50 pc.	20x3/4"
17PK-2605	10 pc. / 50 pc.	26x3/4"
17PK-2606	10 pc. / 40 pc.	26x1"
17PK-3206	10 pc. / 40 pc.	32x1"
17PK-3207	5 pc. / 25 pc.	32x1 1/4"
17PK-4006	5 pc. / 25 pc.	40x1"
17PK-4007	5 pc. / 25 pc.	40x1 1/4"
17PK-5008	1 pc. / 10 pc.	50x1 1/2"
17PK-6310	1 pc. / 6 pc.	63x2"
17PK-7510	See page 54	75x2"
17PK-7512	See page 54	75x2 1/2"

Type: 17PK-N (CW602)



PK-TOOL p 170

Straight male adapter
Recht aansluitstuk buitendraad / Puntstuk
Raccord droit mâle
Übergangsfitting AG

Article number	Bag / Box	Type
17PK-4006-N	5 pc. / 25 pc.	40x1"
17PK-4007-N	5 pc. / 25 pc.	40x1 1/4"
17PK-5008-N	1 pc. / 10 pc.	50x1 1/2"
17PK-6310-N	1 pc. / 6 pc.	63x2"



A. PK

Type: 18PK (CW617)



PK-TOOL p 170

Straight female adapter
 Recht aansluitstuk binnendraad / Schroefbus
 Raccord droit femelle
 Übergangsfitting IG

Article number	Bag / Box	Type
18PK-1404	10 pc. / 80 pc.	14x1/2"
18PK-1604	10 pc. / 80 pc.	16x1/2"
18PK-1804	10 pc. / 80 pc.	18x1/2"
18PK-1805	10 pc. / 50 pc.	18x3/4"
18PK-2004	10 pc. / 80 pc.	20x1/2"
18PK-2005	10 pc. / 50 pc.	20x3/4"
18PK-2605	10 pc. / 50 pc.	26x3/4"
18PK-2606	10 pc. / 40 pc.	26x1"
18PK-3206	10 pc. / 40 pc.	32x1"
18PK-3207	5 pc. / 25 pc.	32x1 1/4"
18PK-4006	5 pc. / 25 pc.	40x1"
18PK-4007	5 pc. / 25 pc.	40x1 1/4"
18PK-5008	1 pc. / 10 pc.	50x1 1/2"
18PK-6310	1 pc. / 6 pc.	63x2"
18PK-7506	1 pc. / 1 pc.	75x1"
18PK-7510	1 pc. / 1 pc.	75x2"
18PK-7512	1 pc. / 1 pc.	75x2 1/2"
18PK-9014	1 pc. / 1 pc.	90x3"

Type: 18PK-N (CW602)



PK-TOOL p 170

Straight female adapter
 Recht aansluitstuk binnendraad / Schroefbus
 Raccord droit femelle
 Übergangsfitting IG

Article number	Bag / Box	Type
18PK-4006-N	5 pc. / 25 pc.	40x1"
18PK-4007-N	5 pc. / 25 pc.	40x1 1/4"
18PK-5008-N	1 pc. / 10 pc.	50x1 1/2"
18PK-6310-N	1 pc. / 6 pc.	63x2"

Type: 19PK



Press fit with swivel to eurocone
 Perskoppeling met wartel en euroconus aansluiting
 Raccord à sertir avec ecrou à visser eurocone
 Pressfitting mit Drehbar und Eurokonus

Article number	Bag / Box	Type
19PK-1605	10 pc. / 80 pc.	16x3/4"
19PK-2005	10 pc. / 80 pc.	20x3/4"



Type: 26PK



Press fitting with swivel and flat sealing
 Perskoppeling met wartel en vlakke dichting
 Raccord avec écrou et joint plat
 Pressfitting mit Drehbar und flach Versiegelung

Article number	Bag / Box	Type
26PK-1605	10 pc. / 80 pc.	16x3/4"
26PK-2005	10 pc. / 80 pc.	20x3/4"

Type: 26PK (CW617)



Press fitting with swivel and flat sealing
 Perskoppeling met wartel en vlakke dichting
 Raccord avec écrou et joint plat
 Pressfitting mit Drehbar und flach Versiegelung

Article number	Bag / Box	Type
26PK-4008	5 pc. / 15 pc.	40x1 1/2"
26PK-5010	1 pc. / 10 pc.	50x2"
26PK-6312	1 pc. / 6 pc.	63x2 1/2"

Type: 27PK



45° bend
 Bocht 45°
 Coude 45°
 Winkel 45°

Article number	Bag / Box	Type
27PK-4040	5 pc. / 25 pc.	40x40
27PK-5050	1 pc. / 10 pc.	50x50
27PK-6363	1 pc. / 5 pc.	63x63
27PK-7575	1 pc. / 1 pc.	75x75
27PK-9090	1 pc. / 1 pc.	90x90

Type: 28PK-04



Bracket wallplate for 2PK, 6PK and 13PK, interaxis 153mm
 Muurplaatbeugel voor 2PK, 6PK en 13PK, asafstand 153mm
 Attache culasse pour 2PK, 6PK et 13PK, entraxe 153mm
 Bügel Wandscheibe für 28PK-2PK1604 und 28PK-6PK-1604, Mitte-zu-Mitte-Abstand

Article number	Box	Type
28PK-04	50 pc.	1/2"

- 1
- 2
- 3
- 4
- 5
- 6
- 7
- 8
- 9
- 10
- 11



A. PK

Type: 28PK-2PK1604



Double backplate 153mm centres for art. 2PK-1604
 Dubbele muurplaat 153mm asafstand voor art. 2PK-1604
 Culasse double, entraxe 153mm pour art. 2PK-1604
 Wandwinkel doppelt 153mm Abstand für Art. 2PK-1604

Article number	Bag / Box	Type
28PK-2PK1604BP *	2 pc. / 10 pc.	2x(16x1/2")

* With black plug BP04 1/2"

TILL EXHAUSTION OF STOCK

Type: 28PK-6PK1604



Double backplate 153mm centres for art. 6PK-1604
 Dubbele muurplaat 153mm asafstand voor art. 6PK-1604
 Culasse double, entraxe 153mm pour art. 6PK-1604
 Wandwinkel doppelt 153mm Abstand für Art. 6PK-1604

Article number	Bag / Box	Type
28PK-6PK1604BP *	2 pc. / 18 pc.	2x(16x1/2")

* With black plug BP04 1/2"

TILL EXHAUSTION OF STOCK

Type: 53PK



Easy mounting fitting
 Eenvoudige montage fitting
 Raccord montage facile
 Einfache Montage Fitting

Article number	Bag / Box	Type
53PK40	1 pc. / 20 pc.	40x40
53PK50	1 pc. / 9 pc.	50x50
53PK63	1 pc. / 6 pc.	63x63

for Ø16, 20, 26 and 32: chapter 4, article 52P



Type: 1PKW



Elbow 90°
Knie 90°
Coude 90°
Winkel 90°

Article number	Bag / Box	Type
1PKW-1616	10 pc. / 120 pc.	16x16
1PKW-2020	10 pc. / 80 pc.	20x20
1PKW-2626	5 pc. / 50 pc.	26x26
1PKW-3232	5 pc. / 30 pc.	32x32

Type: 2PKW (CW617)



Backplate elbow female
Sanitair muurplaat binnendraad
Culasse pour sanitaire
Sanitär Wandscheibe IG

Article number	Bag / Box	Type
2PKW-1604	10 pc. / 50 pc.	16x1/2" (56 mm)
2PKW-2004	10 pc. / 50 pc.	20x1/2" (56 mm)
2PKW-2005	5 pc. / 30 pc.	20x3/4" (56 mm)
2PKW-2605	5 pc. / 30 pc.	26x3/4" (56 mm)

Type: 2PKW-N (CW602)



Backplate elbow female
Sanitair muurplaat binnendraad
Culasse pour sanitaire
Sanitär Wandscheibe IG

Article number	Bag / Box	Type
2PKW-1604-N	10 pc. / 50 pc.	16x1/2" (56 mm)
2PKW-2004-N	10 pc. / 50 pc.	20x1/2" (56 mm)
2PKW-2005-N	5 pc. / 30 pc.	20x3/4" (56 mm)
2PKW-2605-N	5 pc. / 30 pc.	26x3/4" (56 mm)

Type: 2PKW-K (CW617)



Backplate elbow female, short model,
Sanitair muurplaat binnendraad, kort model
Culasse pour sanitaire, modèle court
Sanitär Wandscheibe IG, kurzes Modell

Article number	Bag / Box	Type
2PKW-1604K	10 pc. / 50 pc.	16x1/2" (40 mm)

Accessory 2PKW, 2PKW-N, 2PKW-K: galvanised bracket plate - see page 168



PLP-P-PK



PLF-P-PK



B. PKW

Type: 3PKW (CW617)



Double backplate elbow female, short model
 Sanitair muurplaat binnendraad dubbel, laag
 Culasse double pour sanitaire, modèle court
 Sanitär Wandscheibe doppelt IG, kurzes Modell

Article number	Bag / Box	Type
3PKW-160416	10 pc. / 30 pc.	16x1/2"x16 (40 mm)
3PKW-200420	10 pc. / 30 pc.	20x1/2"x20 (40 mm)

Type: 3PKW-N (CW602)



Double backplate elbow female, short model
 Sanitair muurplaat binnendraad dubbel, laag
 Culasse double pour sanitaire, modèle court
 Sanitär Wandscheibe doppelt IG, kurzes Modell

Article number	Bag / Box	Type
3PKW-160416-N	10 pc. / 30 pc.	16x1/2"x16 (40 mm)
3PKW-200420-N	10 pc. / 30 pc.	20x1/2"x20 (40 mm)

Type: 5PKW (CW617)



PK-TOOL p 170

Bend 90° male adapter
 Knie 90° buitendraad
 Coude 90° mâle
 Winkel 90° AG

Article number	Bag / Box	Type
5PKW-1604	10 pc. / 60 pc.	16x1/2"
5PKW-2004	10 pc. / 60 pc.	20x1/2"
5PKW-2005	10 pc. / 50 pc.	20x3/4"
5PKW-2605	10 pc. / 40 pc.	26x3/4"
5PKW-3206	5 pc. / 20 pc.	32x1"

Type: 5PKW-N (CW602)



PK-TOOL p 170

Bend 90° male adapter
 Knie 90° buitendraad
 Coude 90° mâle
 Winkel 90° AG

Article number	Bag / Box	Type
5PKW-1604-N	10 pc. / 60 pc.	16x1/2"
5PKW-2004-N	10 pc. / 60 pc.	20x1/2"
5PKW-2005-N	10 pc. / 50 pc.	20x3/4"
5PKW-2605-N	10 pc. / 40 pc.	26x3/4"
5PKW-3206-N	5 pc. / 20 pc.	32x1"

B. PKW



Type: 6PKW (CW617)



PK-TOOL p 170

Bend 90° female adapter
Knie 90° binnendraad
Coude 90° femelle
Winkel 90° IG

Article number	Bag / Box	Type
6PKW-1603	10 pc. / 60 pc.	16x3/8"
6PKW-1604	10 pc. / 60 pc.	16x1/2"
6PKW-2004	10 pc. / 60 pc.	20x1/2"
6PKW-2005	10 pc. / 50 pc.	20x3/4"
6PKW-2605	10 pc. / 50 pc.	26x3/4"
6PKW-3206	5 pc. / 20 pc.	32x1"

Type: 6PKW-N (CW602)



PK-TOOL p 170

Bend 90° female adapter
Knie 90° binnendraad
Coude 90° femelle
Winkel 90° IG

Article number	Bag / Box	Type
6PKW-1603-N	10 pc. / 60 pc.	16x3/8"
6PKW-1604-N	10 pc. / 60 pc.	16x1/2"
6PKW-2004-N	10 pc. / 60 pc.	20x1/2"
6PKW-2005-N	10 pc. / 50 pc.	20x3/4"
6PKW-2605-N	10 pc. / 50 pc.	26x3/4"
6PKW-3206-N	5 pc. / 20 pc.	32x1"

Type: 9PKW



T-piece
T-stuk
Pièce en T
T-Stück

Article number	Bag / Box	Type
9PKW-161616	10 pc. / 60 pc.	16x16x16
9PKW-202020	10 pc. / 50 pc.	20x20x20
9PKW-262626	5 pc. / 30 pc.	26x26x26
9PKW-323232	5 pc. / 15 pc.	32x32x32

Type: 10PKW



T-reduced centre
T-verlopend
T-réduit
T-reduziert

Article number	Bag / Box	Type
10PKW-201620	10 pc. / 50 pc.	20x16x20
10PKW-261626	5 pc. / 30 pc.	26x16x26
10PKW-262026	5 pc. / 30 pc.	26x20x26
10PKW-321632	5 pc. / 25 pc.	32x16x32
10PKW-322032	5 pc. / 25 pc.	32x20x32
10PKW-322632	5 pc. / 20 pc.	32x26x32



B. PKW

Type: 11PKW



T-branch and line reduced

T-2X verlopend

T-2X réduit

T-2X reduziert

Article number	Bag / Box	Type
11PKW-201616	10 pc. / 50 pc.	20x16x16
11PKW-202016	10 pc. / 50 pc.	20x20x16
11PKW-261616	10 pc. / 50 pc.	26x16x16
11PKW-261620	5 pc. / 30 pc.	26x16x20
11PKW-262016	5 pc. / 30 pc.	26x20x16
11PKW-262020	5 pc. / 30 pc.	26x20x20
11PKW-262616	5 pc. / 30 pc.	26x26x16
11PKW-262620	5 pc. / 30 pc.	26x26x20
11PKW-322026	5 pc. / 20 pc.	32x20x26
11PKW-322626	5 pc. / 20 pc.	32x26x26

Type: 12PKW



T-enlarged branch

T-vergroot

T-agrandi

T-erweitert

Article number	Bag / Box	Type
12PKW-162016	10 pc. / 50 pc.	16x20x16
12PKW-202620	5 pc. / 30 pc.	20x26x20
12PKW-263226	5 pc. / 20 pc.	26x32x26

Type: 13PKW (CW617)



PK-TOOL p 170

T-female centre

T-binnendraad

T-femelle

T-IG

Article number	Bag / Box	Type
13PKW-160416	10 pc. / 50 pc.	16x1/2"x16
13PKW-200420	10 pc. / 50 pc.	20x1/2"x20
13PKW-200520	10 pc. / 30 pc.	20x3/4"x20
13PKW-260426	5 pc. / 30 pc.	26x1/2"x26
13PKW-260526	5 pc. / 30 pc.	26x3/4"x26
13PKW-320532	5 pc. / 15 pc.	32x3/4"x32
13PKW-320632	5 pc. / 10 pc.	32x1"x32



Type: 13PKW-N (CW602)



PK-TOOL p 170

T-female centre
T-binnendraad
T-femelle
T-IG

Article number	Bag / Box	Type
13PKW-160416-N	10 pc. / 50 pc.	16x1/2"x16
13PKW-200420-N	10 pc. / 50 pc.	20x1/2"x20
13PKW-200520-N	10 pc. / 30 pc.	20x3/4"x20
13PKW-260426-N	5 pc. / 30 pc.	26x1/2"x26
13PKW-260526-N	5 pc. / 30 pc.	26x3/4"x26
13PKW-320532-N	5 pc. / 15 pc.	32x3/4"x32
13PKW-320632-N	5 pc. / 10 pc.	32x1"x32

Type: 14PKW (CW617)



PK-TOOL p 170

T-male centre
T-buitendraad
T-mâle
T-AG

Article number	Bag / Box	Type
14PKW-160416	10 pc. / 50 pc.	16x1/2"x16
14PKW-200420	10 pc. / 40 pc.	20x1/2"x20
14PKW-200520	10 pc. / 30 pc.	20x3/4"x20
14PKW-320532	5 pc. / 15 pc.	32x3/4"x32

Type: 14PKW-N (CW602)



PK-TOOL p 170

T-male centre
T-buitendraad
T-mâle
T-AG

Article number	Bag / Box	Type
14PKW-160416-N	10 pc. / 50 pc.	16x1/2"x16
14PKW-200420-N	10 pc. / 40 pc.	20x1/2"x20
14PKW-200520-N	10 pc. / 30 pc.	20x3/4"x20

Type: 15PKW



Straight coupling
Doorverbinder recht
Manchon
Kupplung

Article number	Bag / Box	Type
15PKW-1616	10 pc. / 150 pc.	16x16
15PKW-2020	10 pc. / 80 pc.	20x20
15PKW-2626	5 pc. / 50 pc.	26x26
15PKW-3232	5 pc. / 30 pc.	32x32



B. PKW

Type: 16PKW



Reducing coupling
Verloopstuk
Réduction
Kupplung-reduziert

Article number	Bag / Box	Type
16PKW-2016	10 pc. / 100 pc.	20x16
16PKW-2616	5 pc. / 60 pc.	26x16
16PKW-2620	5 pc. / 50 pc.	26x20
16PKW-3216	5 pc. / 50 pc.	32x16
16PKW-3220	5 pc. / 40 pc.	32x20
16PKW-3226	5 pc. / 40 pc.	32x26

Type: 17PKW (CW617)



PK-TOOL p 170

Straight male adapter
Recht aansluitstuk buitendraad / Puntstuk
Raccord droit mâle
Übergangsfitting AG

Article number	Bag / Box	Type
17PKW-1604	10 pc. / 80 pc.	16x1/2"
17PKW-2004	10 pc. / 80 pc.	20x1/2"
17PKW-2005	10 pc. / 50 pc.	20x3/4"
17PKW-2605	10 pc. / 50 pc.	26x3/4"
17PKW-2606	10 pc. / 40 pc.	26x1"
17PKW-3206	10 pc. / 40 pc.	32x1"
17PKW-3207	5 pc. / 25 pc.	32 x 1 1/4"

Type: 17PKW-N (CW602)



PK-TOOL p 170

Straight male adapter
Recht aansluitstuk buitendraad / Puntstuk
Raccord droit mâle
Übergangsfitting AG

Article number	Bag / Box	Type
17PKW-1604-N	10 pc. / 80 pc.	16x1/2"
17PKW-2004-N	10 pc. / 80 pc.	20x1/2"
17PKW-2005-N	10 pc. / 50 pc.	20x3/4"
17PKW-2605-N	10 pc. / 50 pc.	26x3/4"
17PKW-2606-N	10 pc. / 40 pc.	26x1"
17PKW-3206-N	10 pc. / 40 pc.	32x1"
17PKW-3207-N	5 pc. / 25 pc.	32 x 1 1/4"



Type: 18PKW (CW617)



PK-TOOL p 170

Straight female adapter
Recht aansluitstuk binnendraad / Schroefbus
Raccord droit femelle
Übergangsfitting IG

Article number	Bag / Box	Type
18PKW-1604	10 pc. / 80 pc.	16x1/2"
18PKW-2004	10 pc. / 80 pc.	20x1/2"
18PKW-2005	10 pc. / 50 pc.	20x3/4"
18PKW-2605	10 pc. / 50 pc.	26x3/4"
18PKW-2606	10 pc. / 40 pc.	26x1"
18PKW-3206	10 pc. / 40 pc.	32x1"
18PKW-3207	5 pc. / 25 pc.	32x1 1/4"

Type: 18PKW-N (CW602)



PK-TOOL p 170

Straight female adapter
Recht aansluitstuk binnendraad / Schroefbus
Raccord droit femelle
Übergangsfitting IG

Article number	Bag / Box	Type
18PKW-1604-N	10 pc. / 80 pc.	16x1/2"
18PKW-2004-N	10 pc. / 80 pc.	20x1/2"
18PKW-2005-N	10 pc. / 50 pc.	20x3/4"
18PKW-2605-N	10 pc. / 50 pc.	26x3/4"
18PKW-2606-N	10 pc. / 40 pc.	26x1"
18PKW-3206-N	10 pc. / 40 pc.	32x1"
18PKW-3207-N	5 pc. / 25 pc.	32x1 1/4"

Type: 19PKW



Press fitting to eurocone
Perskoppeling met euroconus aansluiting
Raccord avec raccord à visser eurocone
Pressfitting mit Eurokonus

Article number	Bag / Box	Type
19PKW-1605	10 pc. / 80 pc.	16x3/4"
19PKW-2005	10 pc. / 80 pc.	20x3/4"

Type: 26PKW



Press fitting with flat sealing
Perskoppeling met vlakke dichting
Raccord avec etachéité plate
Pressfitting mit flach Versiegelung

Article number	Bag / Box	Type
26PKW-1605	10 pc. / 80 pc.	16x3/4"
26PKW-2005	10 pc. / 80 pc.	20x3/4"



C. PKG

Gas: only allowed in countries where has been a HENCO GAS testing + certificate is available! (See www.henco.be)
 Gas: enkel toegelaten in landen waar er een HENCO GAS keur is + een certificaat voorhanden is! (zie www.henco.be)
 Gaz: seulement permis dans des pays où le contrôle a eu lieu + certificat est disponible! (Consultez www.henco.be)
 Gas: nur zugelassen in Länder wo HENCO GAS Prüfung geschehen ist + Zertifikat vorhanden ist! (Siehe www.henco.be)

Henco press fittings PVDF for gas in combination with standard pipe gas, see page 19



Type: 1PKG



Elbow 90°
 Knie 90°
 Coude 90°
 Winkel 90°

Article number	Bag / Box	Type
1PKG-1616	10 pc. / 120 pc.	16x16
1PKG-2020	10 pc. / 80 pc.	20x20
1PKG-2626	5 pc. / 50 pc.	26x26
1PKG-3232	5 pc. / 30 pc.	32x32
1PKG-4040	5 pc. / 20 pc.	40x40

Type: 2PKG



Backplate elbow female
 Muurplaat binnendraad
 Culasse femelle
 Wandscheibe IG

Article number	Bag / Box	Type
2PKG-1603	10 pc. / 50 pc.	16x3/8" (56 mm)
2PKG-1604BP *	10 pc. / 50 pc.	16x1/2" (56 mm)
2PKG-2004BP *	10 pc. / 50 pc.	20x1/2" (56 mm)
2PKG-2005	5 pc. / 30 pc.	20x3/4" (56 mm)
2PKG-2605	5 pc. / 30 pc.	26x3/4" (56 mm)

* With black plug BP04 1/2"

Type: 2PKG-K



Backplate elbow female, short model
 Muurplaat binnendraad, laag
 Culasse femelle, modèle court
 Wandscheibe IG, kurzes Modell

Article number	Bag / Box	Type
2PKG-1604KBP *	10 pc. / 50 pc.	16x1/2" (40 mm)

* With black plug BP04 1/2"



Type: 3PKG



Double backplate elbow female, short model
Muurplaat binnendraad dubbel, laag
Culasse double, modèle court
Wandscheibe doppelt IG, kurzes Modell

Article number	Bag / Box	Type
3PKG-200420BP *	10 pc. / 30 pc.	20x1/2"x20 (40 mm)

** With black plug BP04 1/2"*

Type: 5PKG



PK-TOOL p 170

Bend 90° male adapter
Knie 90° buitendraad
Coude 90° mâle
Winkel 90° AG

Article number	Bag / Box	Type
5PKG-1604	10 pc. / 60 pc.	16x1/2"
5PKG-2004	10 pc. / 60 pc.	20x1/2"
5PKG-2005	10 pc. / 50 pc.	20x3/4"
5PKG-2605	10 pc. / 40 pc.	26x3/4"
5PKG-3206	5 pc. / 20 pc.	32x1"
5PKG-4007	5 pc. / 15 pc.	40x1 1/4"

Type: 6PKG



PK-TOOL p 170

Bend 90° female adapter
Knie 90° binnendraad
Coude 90° femelle
Winkel 90° IG

Article number	Bag / Box	Type
6PKG-1604BP *	10 pc. / 60 pc.	16x1/2"
6PKG-2004BP *	10 pc. / 60 pc.	20x1/2"
6PKG-2005	10 pc. / 50 pc.	20x3/4"
6PKG-2605	10 pc. / 50 pc.	26x3/4"
6PKG-3206	5 pc. / 20 pc.	32x1"
6PKG-4007	5 pc. / 15 pc.	40x1 1/4"

** With black plug BP04 1/2"*

Type: 9PKG



T-piece
T-stuk
Pièce en T
T-Stück

Article number	Bag / Box	Type
9PKG-161616	10 pc. / 60 pc.	16x16x16
9PKG-202020	10 pc. / 50 pc.	20x20x20
9PKG-262626	5 pc. / 30 pc.	26x26x26
9PKG-323232	5 pc. / 15 pc.	32x32x32
9PKG-404040	5 pc. / 10 pc.	40x40x40



Type: 10PKG



T-reduced centre
T-verlopend
Pièce en T réduit
T-reduziert

Article number	Bag / Box	Type
10PKG-201620	10 pc. / 50 pc.	20x16x20
10PKG-261626	5 pc. / 30 pc.	26x16x26
10PKG-262026	5 pc. / 30 pc.	26x20x26
10PKG-321632	5 pc. / 25 pc.	32x16x32
10PKG-322032	5 pc. / 25 pc.	32x20x32
10PKG-322632	5 pc. / 20 pc.	32x26x32
10PKG-401640	5 pc. / 15 pc.	40x16x40
10PKG-402040	5 pc. / 15 pc.	40x20x40
10PKG-402640	5 pc. / 15 pc.	40x26x40
10PKG-403240	5 pc. / 10 pc.	40x32x40

Type: 11PKG



T-branch and line reduced
T-2X verlopend
Pièce en T 2X réduit
T-2X reduziert

Article number	Bag / Box	Type
11PKG-201616	10 pc. / 50 pc.	20x16x16
11PKG-202016	10 pc. / 50 pc.	20x20x16
11PKG-261620	5 pc. / 30 pc.	26x16x20
11PKG-262016	5 pc. / 30 pc.	26x20x16
11PKG-262020	5 pc. / 30 pc.	26x20x20
11PKG-262616	5 pc. / 30 pc.	26x26x16
11PKG-262620	5 pc. / 30 pc.	26x26x20
11PKG-322026	5 pc. / 20 pc.	32x20x26
11PKG-322626	5 pc. / 20 pc.	32x26x26
11PKG-402032	5 pc. / 15 pc.	40x20x32
11PKG-402632	5 pc. / 15 pc.	40x26x32
11PKG-403232	5 pc. / 10 pc.	40x32x32
11PKG-404026	5 pc. / 10 pc.	40x40x26
11PKG-404032	5 pc. / 10 pc.	40x40x32

Type: 12PKG



T-enlarged branch
T-vergroot
Pièce en T agrandi
T-erweitert

Article number	Bag / Box	Type
12PKG-162016	10 pc. / 50 pc.	16x20x16
12PKG-202620	5 pc. / 30 pc.	20x26x20
12PKG-263226	5 pc. / 20 pc.	26x32x26
12PKG-324032	5 pc. / 15 pc.	32x40x32



Type: 13PKG



PK-TOOL p 170

T-female branch
T-binnendraad
Pièce en T femelle
T-IG

Article number	Bag / Box	Type
13PKG-160416BP *	10 pc. / 50 pc.	16x1/2"x16
13PKG-200420BP *	10 pc. / 50 pc.	20x1/2"x20
13PKG-200520	10 pc. / 30 pc.	20x3/4"x20
13PKG-260420BP *	5 pc. / 30 pc.	26x1/2"x20
13PKG-260426BP *	5 pc. / 30 pc.	26x1/2"x26
13PKG-260526	5 pc. / 30 pc.	26x3/4"x26
13PKG-320532	5 pc. / 15 pc.	32x3/4"x32
13PKG-320632	5 pc. / 10 pc.	32x1"x32
13PKG-320732	5 pc. / 10 pc.	32x1 1/4"x32
13PKG-400640	5 pc. / 10 pc.	40x1"x40
13PKG-400740	5 pc. / 10 pc.	40x1 1/4"x40

* With black plug BP04 1/2"

Type: 14PKG



PK-TOOL p 170

T-male branch
T-buitendraad
Pièce en T mâle
T-AG

Article number	Bag / Box	Type
14PKG-160416	10 pc. / 50 pc.	16x1/2"x16
14PKG-200420	10 pc. / 40 pc.	20x1/2"x20
14PKG-260426	5 pc. / 30 pc.	26x1/2"x26
14PKG-260626	5 pc. / 20 pc.	26x1"x26
14PKG-320532	5 pc. / 15 pc.	32x3/4"x32
14PKG-400740	5 pc. / 10 pc.	40x1 1/4"x40

Type: 15PKG



Straight coupling
Doorverbinder recht / perssok
Manchon
Kupplung

Article number	Bag / Box	Type
15PKG-1616	10 pc. / 150 pc.	16x16
15PKG-2020	10 pc. / 80 pc.	20x20
15PKG-2626	5 pc. / 50 pc.	26x26
15PKG-3232	5 pc. / 30 pc.	32x32
15PKG-4040	5 pc. / 25 pc.	40x40



Type: 16PKG



Reducing coupling
Verloopstuk
Réduction
Kupplung-reduziert

Article number	Bag / Box	Type
16PKG-2016	10 pc. / 100 pc.	20x16
16PKG-2616	5 pc. / 60 pc.	26x16
16PKG-2620	5 pc. / 50 pc.	26x20
16PKG-3216	5 pc. / 50 pc.	32x16
16PKG-3220	5 pc. / 40 pc.	32x20
16PKG-3226	5 pc. / 40 pc.	32x26
16PKG-4026	5 pc. / 30 pc.	40x26
16PKG-4032	5 pc. / 25 pc.	40x32

Type: 17PKG



PK-TOOL p 170

Straight male adapter
Recht aansluitstuk buitendraad / Puntstuk
Raccord droit mâle
Übergangsfitting AG

Article number	Bag / Box	Type
17PKG-1604	10 pc. / 80 pc.	16x1/2"
17PKG-2004	10 pc. / 80 pc.	20x1/2"
17PKG-2005	10 pc. / 50 pc.	20x3/4"
17PKG-2605	10 pc. / 50 pc.	26x3/4"
17PKG-2606	10 pc. / 40 pc.	26x1"
17PKG-3206	10 pc. / 40 pc.	32x1"
17PKG-3207	5 pc. / 25 pc.	32x1 1/4"
17PKG-4006	5 pc. / 25 pc.	40x1"
17PKG-4007	5 pc. / 25 pc.	40x1 1/4"

Type: 18PKG



PK-TOOL p 170

Straight female adapter
Recht aansluitstuk binnendraad / Schroefbus
Raccord droit femelle
Übergangsfitting IG

Article number	Bag / Box	Type
18PKG-1604	10 pc. / 80 pc.	16x1/2"
18PKG-2004	10 pc. / 80 pc.	20x1/2"
18PKG-2005	10 pc. / 50 pc.	20x3/4"
18PKG-2605	10 pc. / 50 pc.	26x3/4"
18PKG-2606	10 pc. / 40 pc.	26x1"
18PKG-3206	10 pc. / 40 pc.	32x1"
18PKG-3207	5 pc. / 25 pc.	32x1 1/4"
18PKG-4006	5 pc. / 25 pc.	40x1"
18PKG-4007	5 pc. / 25 pc.	40x1 1/4"

Type: 27PKG



45° bend
Bocht 45°
Coude 45°
Winkel 45°

Article number	Bag / Box	Type
27PKG-4040	5 pc. / 25 pc.	40x40



Sprinkler: only allowed in countries where a HENCO Sprinkler certificate is available! (see www.henco.be)
 Sprinkler: enkel toegelaten in landen waar een HENCO Sprinkler certificaat voorhanden is! (zie www.henco.be)
 Sprinkler: seulement permis dans des pays où le HENCO Sprinkler certificat est disponible! (consultez www.henco.be)
 Sprinkler: nur zugelassen in Länder wo HENCO Sprinkler Zertifikat vorhanden ist! (siehe www.henco.be)

Type: 1PKS



Elbow 90°
Bocht 90°
Coude 90°
Winkel 90°

Article number	Bag / Box	Type
1PKS-2626	5 pc. / 50 pc.	26 x 26
1PKS-3232	5 pc. / 30 pc.	32 x 32
1PKS-4040	5 pc. / 20 pc.	40 x 40
1PKS-5050	1 pc. / 8 pc.	50x 50
1PKS-6363	1 pc. / 6 pc.	63 x 63

Type: 5PKS (CW617)



Elbow 90° male adapter
Bocht 90° buitendraad
Coude 90° mâle
Winkel 90° AG

Article number	Bag / Box	Type
5PKS-3206	5 pc. / 20 pc.	32 x 1"
5PKS-4007	3 pc. / 15 pc.	40 x 1,1/4"
5PKS-5007	1 pc. / 10 pc.	50x 1,1/4"
5PKS-5008	1 pc. / 8 pc.	50x 1,1/2"
5PKS-6310	1 pc. / 4 pc.	63 x 2"

Type: 5PKS-N (CW602)



Elbow 90° male adapter
Bocht 90° buitendraad
Coude 90° mâle
Winkel 90° AG

Article number	Bag / Box	Type
5PKS-3206-N	5 pc. / 20 pc.	32 x 1"
5PKS-4007-N	5 pc. / 15 pc.	40 x 1,1/4"
5PKS-5007-N	1 pc. / 8 pc.	50x 1,1/4"
5PKS-5008-N	1 pc. / 8 pc.	50x 1,1/2"
5PKS-6310-N	1 pc. / 4 pc.	63 x 2"

Type: 6PKS (CW617)



Elbow 90° female adapter
Bocht 90° binnendraad
Coude 90° femelle
Winkel 90° IG

Article number	Bag / Box	Type
6PKS-2604	10 pc. / 50 pc.	26 x 1/2"
6PKS-3204	5 pc. / 20 pc.	32 x 1/2"
6PKS-3206	5 pc. / 20 pc.	32 x 1"
6PKS-4004	3 pc. / 15 pc.	40 x 1/2"
6PKS-4007	5 pc. / 15 pc.	40 x 1,1/4"
6PKS-5004	1 pc. / 8 pc.	50x 1/2"
6PKS-5007	1 pc. / 8 pc.	50x 1,1/4"
6PKS-5008	1 pc. / 8 pc.	50x 1,1/2"
6PKS-6304	1 pc. / 4 pc.	63 x 1/2"
6PKS-6310	1 pc. / 4 pc.	63 x 2"

- 1
- 2
- 3
- 4
- 5
- 6
- 7
- 8
- 9
- 10
- 11



D. PKS

Type: 6PKS-N (CW602)



Elbow 90° female adapter

Bocht 90° binnendraad

Coude 90° femelle

Winkel 90° IG

Article number	Bag / Box	Type
6PKS-2604-N	10 pc. / 50 pc.	26 x 1/2"
6PKS-3204-N	5 pc. / 20 pc.	32 x 1/2"
6PKS-3206-N	5 pc. / 20 pc.	32 x 1"
6PKS-4004-N	3 pc. / 15 pc.	40 x 1/2"
6PKS-4007-N	5 pc. / 15 pc.	40 x 1,1/4"
6PKS-5004-N	1 pc. / 8 pc.	50x 1/2"
6PKS-5007-N	1 pc. / 8 pc.	50x 1,1/4"
6PKS-5008-N	1 pc. / 8 pc.	50x 1,1/2"
6PKS-6304-N	1 pc. / 4 pc.	63 x 1/2"
6PKS-6310-N	1 pc. / 4 pc.	63 x 2"

Type: 9PKS



T-piece

T-stuk

Pièce en T

T-Stück

Article number	Bag / Box	Type
9PKS-262626	5 pc. / 30 pc.	26 x 26 x 26
9PKS-323232	5 pc. / 15 pc.	32 x 32 x 32
9PKS-404040	5 pc. / 10 pc.	40 x 40 x 40
9PKS-505050	1 pc. / 6 pc.	50 x 50 x 50
9PKS-636363	1 pc. / 3 pc.	63 x 63 x 63

Type: 10PKS



T-reduced centre

T-verlopend

Pièce en T réduit

T-reduziert

Article number	Bag / Box	Type
10PKS-322632	5 pc. / 20 pc.	32 x 26 x 32
10PKS-402640	5 pc. / 15 pc.	40 x 26 x 40
10PKS-403240	5 pc. / 10 pc.	40 x 32 x 40
10PKS-503250	1 pc. / 8 pc.	50 x 32 x 50
10PKS-504050	1 pc. / 6 pc.	50 x 40 x 50
10PKS-633263	1 pc. / 3 pc.	63 x 32 x 63
10PKS-634063	1 pc. / 3 pc.	63 x 40 x 63
10PKS-635063	1 pc. / 3 pc.	63 x 50 x 63

Type: 11PKS



T-branch and line reduced

T-2x verlopend

Pièce en T 2x réduit

T-2x reduziert

Article number	Bag / Box	Type
11PKS-403232	5 pc. / 10 pc.	40 x 32 x 32
11PKS-404032	5 pc. / 10 pc.	40 x 40 x 32
11PKS-503240	1 pc. / 10 pc.	50 x 32 x 40
11PKS-504040	1 pc. / 8 pc.	50 x 40 x 40



Type: 12PKS



T-enlarged branch
T-vergroot
Pièce en T agrandi
T-erwittert

Article number	Bag / Box	Type
12PKS-324032	5 pc. / 15 pc.	32 x 40 x 32
12PKS-405040	1 pc. / 8 pc.	40 x 50 x 40

Type: 13PKS (CW617)



T-female branch
T-binnendraad
Pièce en T femelle
T-IG

Article number	Bag / Box	Type
13PKS-260426	5 pc. / 30 pc.	26 x 1/2" x 26
13PKS-320432	5 pc. / 20 pc.	32 x 1/2" x 32
13PKS-320532	5 pc. / 15 pc.	32 x 3/4" x 32
13PKS-320632	5 pc. / 10 pc.	32 x 1" x 32
13PKS-320732	5 pc. / 10 pc.	32 x 1,1/4" x 32
13PKS-400440	5 pc. / 10 pc.	40 x 1/2" x 40
13PKS-400640	5 pc. / 10 pc.	40 x 1" x 40
13PKS-400740	5 pc. / 10 pc.	40 x 1,1/4" x 40
13PKS-500450	1 pc. / 4 pc.	50 x 1/2" x 50
13PKS-500550	1 pc. / 4 pc.	50 x 3/4" x 50
13PKS-500850	1 pc. / 4 pc.	50 x 1,1/2" x 50
13PKS-630463	1 pc. / 2 pc.	63 x 1/2" x 63
13PKS-631063	1 pc. / 2 pc.	63 x 2" x 63

Type: 13PKS-N (CW602)



T-female branch
T-binnendraad
Pièce en T femelle
T-IG

Article number	Bag / Box	Type
13PKS-260426-N	5 pc. / 30 pc.	26 x 1/2" x 26
13PKS-320432-N	5 pc. / 20 pc.	32 x 1/2" x 32
13PKS-320532-N	5 pc. / 15 pc.	32 x 3/4" x 32
13PKS-320632-N	5 pc. / 10 pc.	32 x 1" x 32
13PKS-320732-N	5 pc. / 10 pc.	32 x 1,1/4" x 32
13PKS-400440-N	5 pc. / 10 pc.	40 x 1/2" x 40
13PKS-400640-N	5 pc. / 10 pc.	40 x 1" x 40
13PKS-400740-N	5 pc. / 10 pc.	40 x 1,1/4" x 40
13PKS-500450-N	1 pc. / 4 pc.	50 x 1/2" x 50
13PKS-500550-N	1 pc. / 4 pc.	50 x 3/4" x 50
13PKS-500850-N	1 pc. / 4 pc.	50 x 1,1/2" x 50
13PKS-630463-N	1 pc. / 2 pc.	63 x 1/2" x 63
13PKS-631063-N	1 pc. / 2 pc.	63 x 2" x 63



D. PKS

Type: 14PKS (CW617)



T-male branch
T-buitendraad
Pièce en T male
T-AG

Article number	Bag / Box	Type
14PKS-320532	5 pc. / 15 pc.	32 x 3/4" x 32
14PKS-400640	5 pc. / 10 pc.	40 x 1" x 40
14PKS-400740	5 pc. / 10 pc.	40 x 1,1/4" x 40
14PKS-500850	1 pc. / 5 pc.	50 x 1,1/2" x 50
14PKS-631063	1 pc. / 2 pc.	63 x 2" x 63

Type: 14PKS-N (CW602)



T-male branch
T-buitendraad
Pièce en T male
T-AG

Article number	Bag / Box	Type
14PKS-320532-N	5 pc. / 15 pc.	32 x 3/4" x 32
14PKS-400640-N	5 pc. / 10 pc.	40 x 1" x 40
14PKS-400740-N	5 pc. / 10 pc.	40 x 1,1/4" x 40
14PKS-500850-N	1 pc. / 5 pc.	50 x 1,1/2" x 50
14PKS-631063-N	1 pc. / 2 pc.	63 x 2" x 63

Type: 15PKS



Straight coupling
Doorverbinder recht
Manchon
Kupplung

Article number	Bag / Box	Type
15PKS-2626	5 pc. / 50 pc.	26 x 26
15PKS-3232	5 pc. / 30 pc.	32 x 32
15PKS-4040	5 pc. / 25 pc.	40 x 40
15PKS-5050	1 pc. / 12 pc.	50 x 50
15PKS-6363	1 pc. / 9 pc.	63 x 63

Type: 16PKS



Reducing coupling
Verloopstuk
Réduction
Kupplung-reduziert

Article number	Bag / Box	Type
16PKS-3226	5 pc. / 40 pc.	32 x 26
16PKS-4026	5 pc. / 30 pc.	40 x 26
16PKS-4032	5 pc. / 25 pc.	40 x 32
16PKS-5032	1 pc. / 15 pc.	50 x 32
16PKS-5040	1 pc. / 15 pc.	50 x 40
16PKS-6340	1 pc. / 8 pc.	63 x 40
16PKS-6350	1 pc. / 8 pc.	63 x 50



Type: 17PKS (CW617)



Straight male adapter
Recht aansluitstuk buitendraad
Raccord droit mâle
Übergangsfitting AG

Article number	Bag / Box	Type
17PKS-3206	10 pc. / 40 pc.	32 x 1"
17PKS-3207	5 pc. / 25 pc.	32 x 1,1/4"
17PKS-4006	5 pc. / 25 pc.	40 x 1"
17PKS-4007	5 pc. / 25 pc.	40 x 1,1/4"
17PKS-5008	1 pc. / 10 pc.	50 x 1,1/2"
17PKS-6310	1 pc. / 6 pc.	63 x 2"

Type: 17PKS-N (CW602)



Straight male adapter
Recht aansluitstuk buitendraad
Raccord droit mâle
Übergangsfitting AG

Article number	Bag / Box	Type
17PKS-3206-N	10 pc. / 40 pc.	32 x 1"
17PKS-3207-N	5 pc. / 25 pc.	32 x 1,1/4"
17PKS-4006-N	5 pc. / 25 pc.	40 x 1"
17PKS-4007-N	5 pc. / 25 pc.	40 x 1,1/4"
17PKS-5008-N	1 pc. / 10 pc.	50 x 1,1/2"
17PKS-6310-N	1 pc. / 6 pc.	63 x 2"

Type: 18PKS (CW617)



Straight female adapter
Recht aansluitstuk binnendraad
Raccord droit femelle
Übergangsfitting IG

Article number	Bag / Box	Type
18PKS-2604	10 pc. / 50 pc.	26 x 1/2"
18PKS-2606	10 pc. / 40 pc.	26 x 1"
18PKS-3204	10 pc. / 40 pc.	32 x 1/2"
18PKS-3206	10 pc. / 40 pc.	32 x 1"
18PKS-3207	5 pc. / 25 pc.	32 x 1,1/4"
18PKS-4006	5 pc. / 25 pc.	40 x 1"
18PKS-4007	5 pc. / 25 pc.	40 x 1,1/4"
18PKS-5008	1 pc. / 10 pc.	50 x 1,1/2"
18PKS-6310	1 pc. / 6 pc.	63 x 2"



D. PKS

Type: 18PKS-N (CW602)



Straight coupling
Recht aansluitstuk binnendraad
Raccord droit femelle
Übergangsfitting IG

Article number	Bag / Box	Type
18PKS-2604-N	10 pc. / 50 pc.	26 x 1/2"
18PKS-2606-N	10 pc. / 40 pc.	26 x 1"
18PKS-3204-N	10 pc. / 40 pc.	32 x 1/2"
18PKS-3206-N	10 pc. / 40 pc.	32 x 1"
18PKS-3207-N	5 pc. / 25 pc.	32 x 1,1/4"
18PKS-4006-N	5 pc. / 25 pc.	40 x 1"
18PKS-4007-N	5 pc. / 25 pc.	40 x 1,1/4"
18PKS-5008-N	1 pc. / 10 pc.	50 x 1,1/2"
18PKS-6310-N	1 pc. / 6 pc.	63 x 2"

Type: 27PKS



45° bend
Bocht 45°
Coude 45°
Winkel 45°

Article number	Bag / Box	Type
27PKS-4040	2 pc. / 25 pc.	40 x 40
27PKS-5050	1 pc. / 10 pc.	50 x 50
27PKS-6363	1 pc. / 5 pc.	63 x 63

Type: 50P



Prefab Sprinkler Cup
Prefab Sprinkler Cup
Prefab Sprinkler Cup
Prefab Sprinkler Cup

Article number	Bag / Box	Type
50P-3206	1 pc. / 15 pc.	32x 1"
50P-320604	1 pc. / 15 pc.	32x 1" x 1/2"
50P-320605	1 pc. / 15 pc.	32x 1" x 3/4"
50P43-320604	1 pc. / 15 pc.	32x 1" x 1/2" (43 mm)

E. SUPER SIZES



Detailed overview of Super Size possibilities

A = 75mm

B = 90-110mm

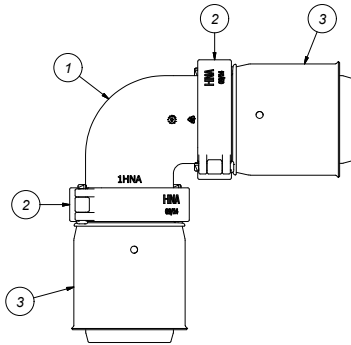

1PK

- 1 HNA or 1HNB
- 2 HNA or HNB
- 3 8HNA-PK40 or 8HNA-PK50 or 8HNA-PK63 or 8HNA-PK75 or 8HNB-PK90

Example / Voorbeeld / Exemple / Beispiel

1PK-7575 = 1x 1HNA + 2xHNA + 2x 8HNA-PK75

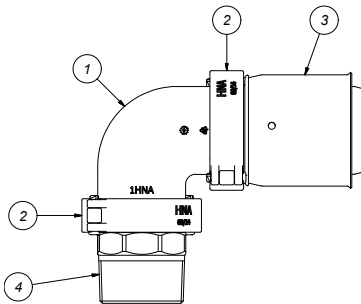

5PK / 6PK

- 1 1HNA or 1HNB
- 2 HNA or HNB
- 3 8HNA-PK75 or 8HNB-PK90
- 4 17HNA-10 or 17HNA-12 or 18HNA-06 or 18HNA-10 or 18HNA-12 or 18HNB-14

Example / Voorbeeld / Exemple / Beispiel

5PK-7510 = 1x 1HNA + 2xHNA + 1x 8HNA-PK75 + 1x17HNA-10

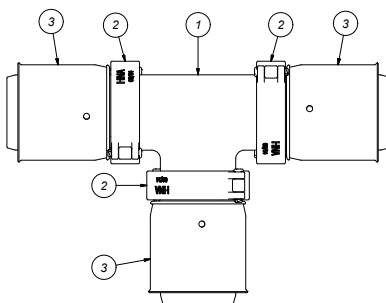

9PK / 10PK / 11PK / 12PK (75mm)

- 1 9HNA
- 2 HNA
- 3 8HNA-PK32 or 8HNA-PK40 or 8HNA-PK50 or 8HNA-PK63 or 8HNA-PK75

Example / Voorbeeld / Exemple / Beispiel

9PK-757575 = 1x 9HNA + 3xHNA + 3x 8HNA-PK75

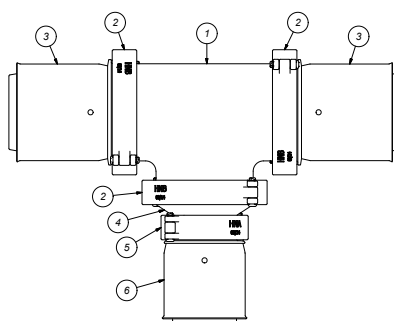

10PK / 11PK / 12PK (90mm)

- 1 9HNB
- 2 HNB
- 3 8HNB-PK90
- 4 16HNB
- 5 HNA
- 6 8HNA-PK32 or 8HNA-PK40 or 8HNA-PK50 or 8HNA-PK63 or 8HNA-PK75

Example / Voorbeeld / Exemple / Beispiel

10PK-905090 = 1x 9HNB + 3x HNB + 2x 8HNB-PK90 + 1x 16HNB + 1xHNA + 8HNA-PK50



E. SUPER SIZES

- 1
- 2
- 3
- 4
- 5
- 6
- 7
- 8
- 9
- 10
- 11

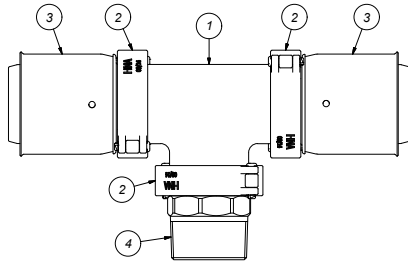

13PK / 14PK

- 1 9HNA or 9HNB
- 2 HNA or HNB
- 3 8HNA-PK75 or 8HNB-PK90
- 4 17HNA-10 or 17HNA-12 or 18HNA-06 or 18HNA-10 or 18HNA-12 or 18HNB-14

Example / Voorbeeld / Exemple / Beispiel

13PK-750675 = 1x 9HNA + 3x HNA + 8HNA-PK75 + 18HNA-06

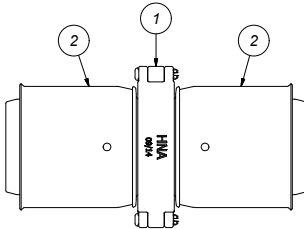

15PK / 16PK

- 1 HNA or HNB
- 2 8HNA-PK75 or 8HNB-PK90

Example / Voorbeeld / Exemple / Beispiel

15PK-7575 = 1x HNA + 2x 8HNA-PK75

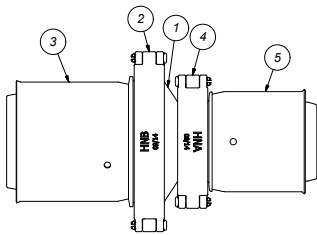

16PK

- 1 16HNBA
- 2 HNB
- 3 8HNB-PK90
- 4 HNA
- 5 8HNA-PK32 or 8HNA-PK40 or 8HNA-PK50 or 8HNA-PK63 or 8HNA-PK75

Example / Voorbeeld / Exemple / Beispiel

16PK-9063 = 1x 16HNBA + 1x HNB + 1x 8HNB-PK90 + 1x HNA + 1x 8HNA-PK63

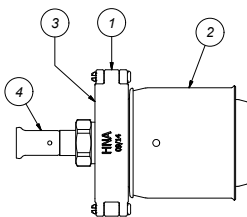

16PK-7516

- 1 HNA
- 2 8HNA-PK75
- 3 HNA-05
- 4 19P-1605 or 19P-1805 or 19P-2005 or 33P-1605 or 19SK-1605 or 19SK-2005

E. SUPER SIZES

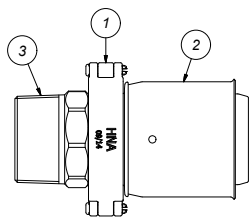

17PK / 18PK

- ① HNA or HNB
- ② 8HNA-PK75 or 8HNB-PK90

Example / Voorbeeld / Exemple / Beispiel

18PK-7512 = 1x HNA + 1x 8HNA-PK75 + 1x 18HNA-12

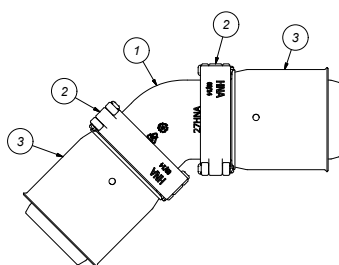

27PK

- ① 27HNA or 27HNB
- ② HNA or HNB
- ③ 8HNA-PK75 or 8HNB-PK90

Example / Voorbeeld / Exemple / Beispiel

27PK-9090 = 1x 27HNB + 2xHNB + 2x 8HNB-PK90

SUPER SIZE MONTAGE

*HN verbinding = "click and lock"
*PK verbinding = persverbinding

MOGELIJKHEDEN

HNA: PK32 / PK40 / PK50 / PK63 / PK75
HNB: PK90

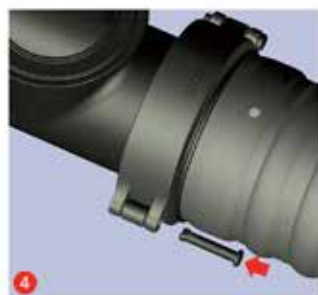
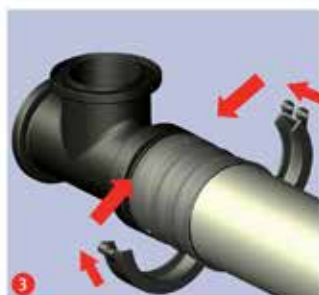
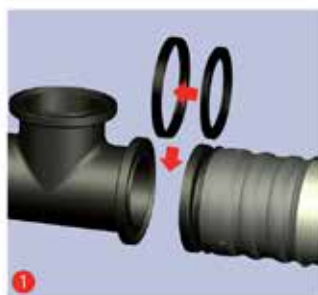



E. SUPER SIZES

Type: 1HN



Elbow 90°
Knie 90°
Coude 90°
Winkel 90°

Article number	Bag / Box	Type
1HNA	1 pc. / 10 pc.	HNAXHNA
1HNB	1 pc. / 1 pc.	HNBxHNB

Type: 9HN



T-piece
T-stuk
Pièce en T
T-Stuck

Article number	Bag / Box	Type
9HNA	1 pc. / 7 pc.	HNAXHNAXHNA
9HNB	1 pc. / 1 pc.	HNBxHNBxHNB

Type: 16HN



Reducing coupling
Verloopstuk
Réduction
Kupplung-reduziert

Article number	Bag / Box	Type
16HNBA	1 pc. / 15 pc.	HNBxHNA

Type: 27HN



Elbow 45°
Bocht 45°
Coude 45°
Winkel 45°

Article number	Bag / Box	Type
27HNA	1 pc. / 15 pc.	HNAXHNA
27HNB	1 pc. / 1 pc.	HNBxHNB

Type: 8HN



Pressfitting
Persfitting
Raccord à sertir
Pressfitting

Article number	Bag / Box	Type
8HNA-PK32	1 pc. / 20 pc	HNAX32
8HNA-PK40	1 pc. / 20 pc.	HNAX40
8HNA-PK50	1 pc. / 15 pc.	HNAX50
8HNA-PK63	1 pc. / 12 pc.	HNAX63
8HNA-PK75	1 pc. / 12 pc.	HNAX75
8HNB-PK90	1 pc. / 4 pc.	HNBx90

E. SUPER SIZES



Type: HN



Bracket set
Beugel set
Support
Bügel Set

Article number	Bag / Box	Type
HNA	1 pc. / 1 pc.	
HNB	1 pc. / 1 pc.	

Type: HN-PEN



Locking pin
Beugelpin
Goupille de verrouillage
Sicherungsstift

Article number	Bag / Box	Type
HN-PEN	50 pc. / 50 pc.	

Type: HN-U



Sealing ring
Dichtingsring
Anneau d'étanchéité
Dichtungsring

Article number	Bag / Box	Type
HNA-U	10 pc. / 10 pc.	HNA
HNB-U	10 pc. / 10 pc.	HNB

Type: 17HN (CW617)



Brass adapter male
Messing adapter buitendraad
Raccord en laiton mâle
Anschluss Bügel AG

Article number	Bag / Box	Type
17HNA-10	1 pc. / 22 pc.	HNAx2"
17HNA-12	1 pc. / 18 pc.	HNAx2 1/2"

Type: 17HN-N (CW602)



Brass adapter male
Messing adapter buitendraad
Raccord en laiton mâle
Anschluss Bügel AG

Article number	Bag / Box	Type
17HNA-10-N	1 pc. / 22 pc.	HNAx2"
17HNA-12-N	1 pc. / 18 pc.	HNAx2 1/2"



E. SUPER SIZES

Type: 18HN (CW617)



Brass adapter female
Messing adapter binnendraad
Raccord en laiton femelle
Anschluss Bügel IG

Article number	Bag / Box	Type
18HNA-06	1 pc. / 40 pc.	HNAx1"
18HNA-10	1 pc. / 27 pc.	HNAx2"
18HNA-12	1 pc. / 16 pc.	HNAx2 1/2"
18HNB-14	1 pc. / 12 pc.	HNBx3"

Type: 18HN-N (CW602)



Brass adapter female
Messing adapter binnendraad
Raccord en laiton femelle
Anschluss Bügel IG

Article number	Bag / Box	Type
18HNA-06-N	1 pc. / 40 pc.	HNAx1"
18HNA-10-N	1 pc. / 27 pc.	HNAx2"
18HNA-12-N	1 pc. / 16 pc.	HNAx2 1/2"
18HNB-14-N	1 pc. / 12 pc.	HNBx3"

Type: HN-STOP



Stop end for Super Size range
Eindstop voor Super Size gamma
Bouchon d'arrêt Super Size
Endkappe für das Sortiment Super Size

Article number	Bag / Box	Type
HNA-STOP	1 pc. / 90 pc.	HNA
HNB-STOP	1 pc. / 40 pc.	HNB

Type: HNA-EK05



Adapter HNA x EK 3/4"
Overgang HNA x EK 3/4"
Réduction HNA x EK 3/4"
Übergang HNA x EK 3/4"

Article number	Bag / Box	Type
HNA-EK05	1 pc. / 50 pc.	HNA x 3/4" EK



Type: HNA-ECOLINE-SET



Basic set for Inliner
 Basisset voor Inliner
 Set de base pour Inliner
 Grundsatz für Inliner

Article number	Bag / Box	Type
HNA-ECOLINE-SET	1 pc. / -	

Composition:
 1x 9HNA (T-piece)
 4x HNA (Bracket set)
 1x HNA-EK05 (Adapter HNA-EK)
 1x HNA-INLB (Base plate for inliner)

The Henco ECO-line is an energy saving solution for recirculation loops, which limits heat loss between supply and return pipe.

A separate pipe for the circulation water is no longer required.

Designed on the Henco Super Size concept, it also combines modularity and easy installation.

ONE CONCEPT FOR ALL DIMENSIONS FROM 40 UP TO 75MM

- Cost effective
- Easy installation
- Less space consumption
- Anti legionellosis

Necessary items to complete the ECOLINE installation *

Article number	Description	Page
8HNA-PK...	Press fitting 40, 50, 63 or 75	56
100-MXC1620	Henco 1L PE-Xc 16x2 - 100m	-
19P-1605	Nickel plated press-fit adapter to eurocone 16x3/4"	79
19P-2005	Nickel plated press-fit adapter to eurocone 20x3/4"	79
33P-1605	Nickel plated press-fit adapter to eurocone 90°	83
19PK-1605	Press fit swivel to eurocone 16x3/4"	32
19PK-2005	Press fit swivel to eurocone 20x3/4"	32
19SK-1605	Push fitting with eurocone connection 16x3/4"	65
19SK-2005	Push fitting with eurocone connection 20x3/4"	65



* To complete the Ecoline installation you need to have a circulator and thermostatic balancing valve (not in Henco range)



	<i>Page</i>
A. SK	61
B. MANIFOLDS	67



Type: 1SK



Elbow 90°

Knie 90°

Coude 90°

Winkel 90°

Article number	Bag / Box	Type
1SK-1616	10 pc. / 70 pc.	16x16
1SK-2020	10 pc. / 50 pc.	20x20
1SK-2626	5 pc. / 40 pc.	26x26

Type: 2SK



Backplate elbow female

Sanitair muurplaat binnendraad

Culasse pour sanitaire femelle

Sanitär Wandscheibe IG

Article number	Bag / Box	Type
2SK-1604BP*	10 pc. / 40 pc.	16x1/2" (56 mm)
2SK-2004BP*	10 pc. / 40 pc.	20X1/2" (56 mm)
2SK-2005	10 pc. / 30 pc.	20X3/4" (56 mm)
2SK-2605	5 pc. / 20 pc.	26X3/4" (56 mm)

* With black plug BP04 1/2"

Type: 2S



Backplate elbow female, short model

Sanitair muurplaat binnendraad kort

Culasse pour sanitaire femelle, modèle court

Sanitär Wandscheibe IG, kurzes Modell

Article number	Bag / Box	Type
2S-1604K	10 pc. / 50 pc.	16x1/2" (43 mm)

Type: 3SK



Double backplate elbow female, short model

Dubbel sanitair muurplaat binnendraad, laag

Culasse double pour sanitaire, modèle court

Sanitär Wandscheibe doppelt IG, kurzes Modell

Article number	Bag / Box	Type
3SK-160416BP *	10 pc. / 30 pc.	16X1/2" (40 mm)
3SK-200420BP *	10 pc. / 30 pc.	20X1/2" (40 mm)

* With black plug BP04 1/2"



A. SK

Type: 5SK



PK-TOOL p 170

Bend 90° male adapter
Knie 90° buitendraad
Coude 90° mâle
Winkel 90° AG

Article number	Bag / Box	Type
5SK-1604	10 pc. / 60 pc.	16X1/2"
5SK-2004	10 pc. / 50 pc.	20X1/2"
5SK-2005	10 pc. / 40 pc.	20X3/4"
5SK-2605	5 pc. / 30 pc.	26X3/4"

Type: 6SK



PK-TOOL p 170

Bend 90° female adapter
Knie 90° binnendraad
Coude 90° femelle
Winkel 90° IG

Article number	Bag / Box	Type
6SK-1604BP *	10 pc. / 60 pc.	16X1/2"
6SK-2004BP *	10 pc. / 60 pc.	20X1/2"
6SK-2005	10 pc. / 30 pc.	20X3/4"
6SK-2605	10 pc. / 30 pc.	26X3/4"

* With black plug BP04 1/2"

Type: 9SK



T-piece
T-stuk
Pièce en T
T-Stuck

Article number	Bag / Box	Type
9SK-161616	10 pc. / 40 pc.	16x16x16
9SK-202020	10 pc. / 30 pc.	20x20x20
9SK-262626	5 pc. / 20 pc.	26x26x26

Type: 10SK



T-reduced centre
T-verlopend
Pièce en T réduit
T-reduziert

Article number	Bag / Box	Type
10SK-201620	10 pc. / 40 pc.	20x16x20
10SK-261626	5 pc. / 25 pc.	26x16x26
10SK-262026	5 pc. / 20 pc.	26x20x26



- 1
- 2
- 3
- 4
- 5
- 6
- 7
- 8
- 9
- 10
- 11

Type: 11SK



T-branch and line reduced
 T-2X verlopend
 Pièce en T 2X réduit
 T-2X rezuizert

Article number	Bag / Box	Type
11SK-201616	10 pc. / 40 pc.	20x16x16
11SK-202016	10 pc. / 30 pc.	20x20x16
11SK-261620	5 pc. / 25 pc.	26x16x20
11SK-262016	5 pc. / 25 pc.	26x20x16
11SK-262020	5 pc. / 25 pc.	26x20x20
11SK-262616	5 pc. / 25 pc.	26x26x16
11SK-262620	5 pc. / 20 pc.	26x26x20

Type: 12SK



T-enlarged branch
 T-vergroot
 Pièce en T agrandi
 T-erweitert

Article number	Bag / Box	Type
12SK-162016	10 pc. / 40 pc.	16x20x16
12SK-202620	5 pc. / 30 pc.	20x26x20

Type: 13SK



PK-TOOL p 170

T-female centre
 T-binnendraad
 Pièce en T femelle
 T-IG

Article number	Bag / Box	Type
13SK-160416BP *	10 pc. / 40 pc.	16x1/2"x16
13SK-200420BP *	10 pc. / 30 pc.	20x1/2"x20
13SK-200520	10 pc. / 30 pc.	20x3/4"x20
13SK-260420BP *	5 pc. / 20 pc.	26x1/2"x20
13SK-260426BP *	5 pc. / 20 pc.	26x1/2"x26
13SK-260526	5 pc. / 20 pc.	26x3/4"x26

* With black plug BP04 1/2"

Type: 14SK



PK-TOOL p 170

T-male centre
 T-buitendraad
 Pièce en T mâle
 T-AG

Article number	Bag / Box	Type
14SK-160416	10 pc. / 40 pc.	16x1/2"x16
14SK-200420	10 pc. / 30 pc.	20x1/2"x20
14SK-260426	5 pc. / 20 pc.	26x1/2"x26



A. SK

1

Type: 15SK

2

3

4

5

6

7



Straight coupling
Doorverbinder recht
Manchon
Kupplung

Article number	Bag / Box	Type
15SK-1616	10 pc. / 70 pc.	16x16
15SK-2020	10 pc. / 60 pc.	20x20
15SK-2626	5 pc. / 30 pc.	26x26

8

Type: 16SK

9

10

11



Reducing coupling
Verloopstuk
Réduction
Kupplung-reduziert

Article number	Bag / Box	Type
16SK-2016	10 pc. / 80 pc.	20x16
16SK-2616	10 pc. / 50 pc.	26x16
16SK-2620	10 pc. / 40 pc.	26x20

Type: 17SK



PK-TOOL p 170

Straight male adapter
Recht aansluitstuk buitendraad / Puntstuk
Raccord droit mâle
Übergangsfitting AG

Article number	Bag / Box	Type
17SK-1603	10 pc. / 80 pc.	16x3/8"
17SK-1604	10 pc. / 80 pc.	16x1/2"
17SK-2004	10 pc. / 60 pc.	20x1/2"
17SK-2005	10 pc. / 60 pc.	20x3/4"
17SK-2605	10 pc. / 40 pc.	26x3/4"
17SK-2606	10 pc. / 40 pc.	26x1"

Type: 18SK



PK-TOOL p 170

Straight female adapter
Recht aansluitstuk binnendraad / Schroefbus
Raccord droit femelle
Übergangsfitting IG

Article number	Bag / Box	Type
18SK-1604	10 pc. / 80 pc.	16x1/2"
18SK-2004	10 pc. / 80 pc.	20x1/2"
18SK-2005	10 pc. / 60 pc.	20x3/4"
18SK-2605	10 pc. / 50 pc.	26x3/4"
18SK-2606	10 pc. / 40 pc.	26x1"



Type: 17SKS



Straight nipple male (brass)
Recht aansluitstuk buitendraad (messing)
Raccord droit mâle (laiton)
Übergangsfitting AG (Messing)

Article number	Bag / Box	Type
17SKS-2004	5 pc. / 150 pc.	20x1/2"
17SKS-2005	5 pc. / 150 pc.	20x3/4"
17SKS-2604	5 pc. / 100 pc.	26x1/2"
17SKS-2605	5 pc. / 100 pc.	26x3/4"

Applicable with HENCO Vision fittings & manifolds

Type: 18SKS



Straight nipple female (brass)
Recht aansluitstuk binnendraad (messing)
Raccord droit femelle (laiton)
Übergangsfitting IG (Messing)

Article number	Bag / Box	Type
18SKS-2004	5 pc. / 150 pc.	20x1/2"
18SKS-2005	5 pc. / 100 pc.	20x3/4"
18SKS-2604	5 pc. / 100 pc.	26x1/2"
18SKS-2605	5 pc. / 80 pc.	26x3/4"

Applicable with HENCO Vision fittings & manifolds

Type: 19SK



Push fitting with eurocone connection
Steekkoppeling met euroconus-aansluiting
Raccord push fit avec eurocone
Steckkupplung mit Eurokonus

Article number	Bag / Box	Type
19SK-1605	10 pc. / 80 pc.	16x3/4"
19SK-2005	10 pc. / 80 pc.	20x3/4"

Type: 26SK



Push fitting with swivel and flat sealing
Steekkoppeling met wartel en vlakke dichting
Raccord push fit avec raccord ecrou etanchéité plate
Steckkupplung mit Drehbar und flach Versiegelung

Article number	Bag / Box	Type
26SK-1605	10 pc. / 80 pc.	16x3/4"
26SK-2005	10 pc. / 80 pc.	20x3/4"

- 1
- 2
- 3
- 4
- 5
- 6
- 7
- 8
- 9
- 10
- 11

Type: SK-PIPESTOP



Stop end for pipe
Eindstop voor buis
Bouchon pour tube
Endkappe für Rohre

Article number	Bag / Box	Type
SK-PIPESTOP16	10 pc. / 120 pc.	16
SK-PIPESTOP20	10 pc. / 80 pc.	20
SK-PIPESTOP26	10 pc. / 80 pc.	26

Type: SK-STOPCLIP



Reusable stop and clip for push fit connection
Herbruikbare stop en clip passend in een steekkoppeling
Bouchon et clip réutilisables pour connection push fit
Stopfen und clip für Steckanschluss, wieder verwendbar

Article number	Bag / Box	Type
SK-STOPCLIP16	10 pc. / 120 pc.	16
SK-STOPCLIP20	10 pc. / 100 pc.	20
SK-STOPCLIP26	10 pc. / 80 pc.	26

Type: VISION SET



Vision revision set
Vision revisie set
Set de révision Vision
Vision set

Article number	Bag / Box	Type
VISION SET 16	1 pc. / 100 pc.	16
VISION SET 20	1 pc. / 90 pc.	20
VISION SET 26	1 pc. / 80 pc.	26

Type: VISION KEY



Vision disassembly key
Vision demontage sleutel
Clé de démontage Vision
Vision Entriegelungsschlüssel

Article number	Bag / Box	Type
VISION-KEY16	1 pc. / 200 pc.	16
VISION-KEY20	1 pc. / 200 pc.	20
VISION-KEY26	1 pc. / 200 pc.	26

B. MANIFOLDS



Type: VSK-1616



Extension or body for manifold, two SK connections Ø16
Verlengstuk of basis voor verdeler, twee SK-aansluitingen Ø16
Complément ou base collecteur, deux sorties SK Ø16
Erweiterung oder Basiskörper für Verteiler, zwei SK-Anschlüssen Ø16

Article number	Bag / Box	Type
VSK-1616	1 pc. / 14 pc.	1616

Type: VSK-161616



Extension or body for manifold, three SK connections Ø16
Verlengstuk of basis voor verdeler, drie SK-aansluitingen Ø16
Complément ou base collecteur, trois sorties SK Ø16
Erweiterung oder Basiskörper für Verteiler, drei SK-Anschlüssen Ø16

Article number	Bag / Box	Type
VSK-161616	1 pc. / 14 pc.	161616

Type: VSKEK-0502



Extension or body for manifold, two eurocone connections
Verlengstuk of basis voor verdeler, twee euroconus-aansluitingen
Complément ou base collecteur, deux sorties eurocone
Erweiterung oder Basiskörper für Verteiler, zwei Eurokonus-Anschlüssen

Article number	Bag / Box	Type
VSKEK-0502	10 pc. / 30 pc.	2x3/4"

Type: VSKEK-0503



Extension or body for manifold, three eurocone connections
Verlengstuk of basis voor verdeler, drie euroconus-aansluitingen
Complément ou base collecteur, trois sorties eurocone
Erweiterung oder Basiskörper für Verteiler, drei Eurokonus-Anschlüssen

Article number	Bag / Box	Type
VSKEK-0503	10 pc. / 30 pc.	3x3/4"

B. MANIFOLDS

Type: 19SK



Push fitting with eurocone connection
 Steekkoppeling met euroconus-aansluiting
 Raccord push fit avec eurocone
 Steckkupplung mit Eurokonus

Article number	Bag / Box	Type
19SK-1605	10 pc. / 80 pc.	16x3/4"
19SK-2005	10 pc. / 80 pc.	20x3/4"

Type: VVSK



Straight entry piece
 Voeding voor verdeler
 Départ collecteur
 Eingang für Verteiler

Article number	Bag / Box	Type
VVSK-20	10 pc. / 80 pc.	20
VVSK-26	10 pc. / 80 pc.	26

Type: VVSK-TM



T-piece for supply for Vision manifold
 Aanvoer T-stuk voor Vision manifold
 Départ pièce en T collecteur Vision
 T-Stück für Vorlauf für Vision Verteiler

Article number	Bag / Box	Type
VVSK-T20M20	10 pc. / 30 pc.	20-20
VVSK-T26M26	5 pc. / 20 pc.	26-26

Type: 17SKS



Straight nipple male (brass)
 Recht aansluitstuk buitendraad (messing)
 Raccord droit mâle (laition)
 Übergangsfitting AG (Messing)

Article number	Bag / Box	Type
17SKS-2004	5 pc. / 150 pc.	20 x 1/2"
17SKS-2005	5 pc. / 150 pc.	20 x 3/4"
17SKS-2604	5 pc. / 100 pc.	26 x 1/2"
17SKS-2605	5 pc. / 100 pc.	26 x 3/4"

Applicable with HENCO Vision fittings & manifolds

B. MANIFOLDS



Type: 18SKS



Straight nipple female (brass)
 Recht aansluitstuk binnendraad (messing)
 Raccord droit femelle (laiton)
 Übergangsfitting IG (Messing)

Article number	Bag / Box	Type
18SKS-2004	5 pc. / 150 pc.	20 x 1/2"
18SKS-2005	5 pc. / 100 pc.	20 x 3/4"
18SKS-2604	5 pc. / 100 pc.	26 x 1/2"
18SKS-2605	5 pc. / 80 pc.	26 x 3/4"

Applicable with HENCO Vision fittings & manifolds

Type: VVSK-90



Elbow 90° for manifold
 Knie 90° voor verdeler
 Coude 90° pour collecteur
 Winkel 90° für Verteiler

Article number	Bag / Box	Type
VVSK-20-90	10 pc. / 70 pc.	20-90
VVSK-26-90	10 pc. / 50 pc.	26-90

Type: VVSK-T



T for manifold
 T voor verdeler
 Piece en T pour collecteur
 T für Verteiler

Article number	Bag / Box	Type
VVSK-T202020	10 pc. / 40 pc.	20-20-20
VVSK-T262626	10 pc. / 20 pc.	26-26-26

Type: VS-ENDCAP



Endcap female for manifold
 Eindkap binnendraad voor verdeler
 Bouchon femelle pour collecteur
 Endkappe IG für Verteiler

Article number	Bag / Box	Type
VS-ENDCAP	10 pc. / 180 pc.	F

B. MANIFOLDS

Type: VS-ENDCAP-M



End plugmale for manifold
Eindstop buitendraad voor verdeler
Bouchon mâle pour collecteur
Endkappe AG für Verteiler

Article number	Bag / Box	Type
VS-ENDCAP-M	10 pc. / 150 pc.	M

Type: ENDCAP-EK05



Eurocone endcap 3/4" white
Euroconus-eindkap 3/4" wit
Eurocone bouchon 3/4" blanc
Eurokonus Endkappe 3/4" Weiss

Article number	Bag / Box	Type
ENDCAP-EK05	10 pc. / 200 pc.	3/4"

Type: VDSK



Straight female adapter for manifold or manifold extension
Doorverbinder voor montage op verdeler of verlengstuk
Manchon pour bout de collecteur
Ausgang für Verteiler

Article number	Bag / Box	Type
VDSK-20	10 pc. / 80 pc.	20
VDSK-26	10 pc. / 60 pc.	26

Type: SK-STOPCLIP



Reusable stop and clip for push fit connection
Herbruikbare stop en clip passend in een steekkoppeling
Bouchon et clip réutilisables pour connection push fit
Stopfen und clip für Steckanschluss, wieder verwendbar

Article number	Bag / Box	Type
SK-STOPCLIP16	10 pc. / 120 pc.	16
SK-STOPCLIP20	10 pc. / 100 pc.	20
SK-STOPCLIP26	10 pc. / 80 pc.	26

Type: SK-B05



Bracket for Vision manifolds
Montagebeugel voor Vision verdelers
Double support pour collecteurs Vision
Halter für Vision Verteiler

Article number	pc / Box	Typ
SK-B05	1 pc. / 200 pc.	B05

B. MANIFOLDS



POSSIBLE COMBINATIONS

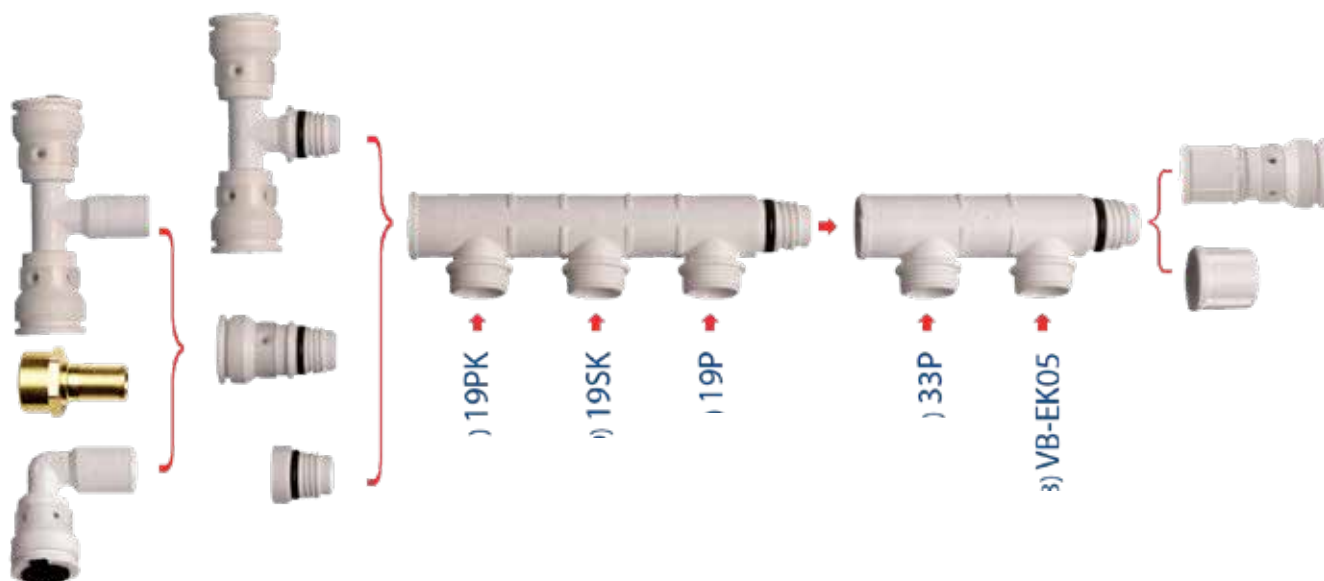

- 1
- 2
- 3
- 4
- 5
- 6
- 7
- 8
- 9
- 10
- 11

Type: 41S



Brass Vision coupling with valve F-connection
 Messing Vision koppeling met F-aansluiting
 Connecteur Vision F
 Vision Fitting mit F-Verbindung

Article number	Bag / Box	Typ
41S-20	10 pc. / 60 pc.	20
41S-26	10 pc. / 80 pc.	26

Type: 41SKS



Connection Vision coupling with valve F-connection
 Aansluitstuk Vision koppeling met F-aansluiting
 Raccord Vision Connecteur Vision F
 Messing Übergang Vision Fitting mit F-Verbindung

Article number	Bag / Box	Typ
41SKS-20	10 pc. / 80 pc.	20
41SKS-26	10 pc. / 80 pc.	26

BA-F41 (p. 109)



BRASS PRESS FITTINGS - MESSING PERSKOPPELINGEN - RACCORDS À SERTIR EN LAITON - MESSING PRESSFITTINGE



	<i>Page</i>
<i>A. P</i>	<i>73</i>
<i>B. PG</i>	<i>87</i>



Type: 1P



Elbow 90°
Knie 90°
Coude 90°
Winkel 90°

Article number	Bag / Box	Type
1P-1414	10 pc. / 150 pc.	14x14
1P-1616	10 pc. / 150 pc.	16x16
1P-1818	10 pc. / 100 pc.	18x18
1P-2020	10 pc. / 80 pc.	20x20
1P-2626	5 pc. / 50 pc.	26x26
1P-3232	5 pc. / 50 pc.	32x32

Type: 2P



Backplate elbow female
Sanitair muurplaat binnendraad
Culasse pour sanitaire femelle
Sanitär Wandscheibe IG

Article number	Bag / Box	Type
2P-1604	10 pc. / 50 pc.	16x1/2" (52 mm)
2P-1804	10 pc. / 50 pc.	18x1/2" (52 mm)
2P-2004	10 pc. / 50 pc.	20x1/2" (52 mm)
2P-2005	10 pc. / 50 pc.	20x3/4" (52 mm)
2P-2605	5 pc. / 50 pc.	26x3/4" (52 mm)

Type: 2P-K



Backplate elbow female, short model
Sanitair muurplaat binnendraad, laag
Culasse pour sanitaire femelle, modèle court
Sanitär Wandscheibe IG, kurzes Modell

Article number	Bag / Box	Type
2P-1404K	10 pc. / 50 pc.	14x1/2" (35 mm)
2P-1604K	10 pc. / 50 pc.	16x1/2" (35 mm)

Accessory 2P & 2P-K: galvanised bracket plate - see page 172



PLP-P-PK



PLF-P-PK

Type: 3P



Double backplate elbow female
Sanitaire muurplaat binnendraad, dubbel
Culasse double pour sanitaire femelle
Sanitär Wandscheibe doppelt IG

Article number	Bag / Box	Type
3P-160416	10 pc. / 40 pc.	16x1/2"x16 (52 mm)
3P-200420	10 pc. / 40 pc.	20x1/2"x20 (52 mm)

- 1
- 2
- 3
- 4
- 5
- 6
- 7
- 8
- 9
- 10
- 11

Type: 3P-VK



Double backplate female (flow), short model
Doorstroom muurplaat binnendraad, laag
Culasse double femelle (écoulement), modèle court
Wandscheibe doppelt IG (Fluss), kurzes Modell

Article number	Bag / Box	Type
3P-160416VK	5 pc. / 20 pc.	16x1/2"x16 (40 mm)
3P-200420VK	5 pc. / 20 pc.	20x1/2"x20 (40 mm)

Type: 4P



Backplate elbow female, extended model
Sanitair muurplaat binnendraad, hoog
Culasse pour sanitaire femelle, modèle long
Sanitär Wandscheibe IG, langes Modell

Article number	Bag / Box	Type
4P-1604	10 pc. / 40 pc.	16x1/2" (78 mm)
4P-1804	10 pc. / 40 pc.	18x1/2" (78 mm)
4P-2004	10 pc. / 40 pc.	20x1/2" (78 mm)

Accessory 3P-VK & 4P : galvanised bracket plate - see page 172



PLP-P-PK



PLF-P-PK

Type: 5P



Bend 90° male adapter
Knie 90° buitendraad
Coude 90° mâle
Winkel 90° AG

Article number	Bag / Box	Type
5P-1404	10 pc. / 150 pc.	14x1/2"
5P-1603	10 pc. / 150 pc.	16x3/8"
5P-1603DZR *	10 pc. / 150 pc.	16x3/8"
5P-1604	10 pc. / 150 pc.	16x1/2"
5P-1604DZR *	10 pc. / 150 pc.	16x1/2"
5P-1804	10 pc. / 120 pc.	18x1/2"
5P-2004	10 pc. / 100 pc.	20x1/2"
5P-2005	10 pc. / 80 pc.	20x3/4"
5P-2605	10 pc. / 60 pc.	26x3/4"
5P-3206 **	5 pc. / 25 pc.	32x1"

* DZR = Brass alloy CW602N"

**TILL EXHAUSTION OF STOCK



Type: 6P



Bend 90° female adapter
Knie 90° binnendraad
Coude 90° femelle
Winkel 90° IG

Article number	Bag / Box	Type
6P-1404	10 pc. / 120 pc.	14x1/2"
6P-1604	10 pc. / 120 pc.	16x1/2"
6P-1804	10 pc. / 120 pc.	18x1/2"
6P-2004	10 pc. / 120 pc.	20x1/2"
6P-2005	10 pc. / 50 pc.	20x3/4"
6P-2605	5 pc. / 50 pc.	26x3/4"

*TILL EXHAUSTION OF STOCK

Type: 7P



Backplate elbow male
Sanitair muurplaat buitendraad met binnendraad 1/2"
Culasse pour sanitaire mâle
Sanitär Wandscheibe AG

Article number	Bag / Box	Type
7P-1605	10 pc. / 30 pc.	16x3/4" (78 mm)
7P-2005	10 pc. / 30 pc.	20x3/4" (78 mm)
7P-1605K	5 pc. / 30 pc.	16x3/4" (60 mm)
7P-1605L	5 pc. / 30 pc.	16x3/4" (70 mm)

Type: 8P



Sanitary adapter female
Sanitair aansluitstuk met binnendraad
Culasse pour sanitaire femelle
UP-Spülkastenwinkel

Article number	Bag / Box	Type
8P-1604	10 pc. / 50 pc.	16x1/2"

Type: 9P



T-piece
T-stuk
Pièce en T
T-Stück

Article number	Bag / Box	Type
9P-141414	10 pc. / 100 pc.	14x14x14
9P-161616	10 pc. / 60 pc.	16x16x16
9P-181818	10 pc. / 60 pc.	18x18x18
9P-202020	10 pc. / 50 pc.	20x20x20
9P-262626	5 pc. / 30 pc.	26x26x26
9P-323232 *	1 pc. / 20 pc.	32x32x32

*TILL EXHAUSTION OF STOCK



- 1
- 2
- 3
- 4
- 5
- 6
- 7
- 8
- 9
- 10
- 11

Type: 10P**T-reduced centre****T-verlopend****Pièce en T réduit****T-reduziert**

Article number	Bag / Box	Type
10P-161416	10 pc. / 50 pc.	16x14x16
10P-181618	10 pc. / 50 pc.	18x16x18
10P-201620	10 pc. / 50 pc.	20x16x20
10P-201820	10 pc. / 50 pc.	20x18x20
10P-261626	5 pc. / 30 pc.	26x16x26
10P-261826	5 pc. / 30 pc.	26x18x26
10P-262026	5 pc. / 30 pc.	26x20x26
10P-321632 *	5 pc. / 20 pc.	32x16x32
10P-322032 *	5 pc. / 20 pc.	32x20x32
10P-322632 *	5 pc. / 20 pc.	32x26x32

TILL EXHAUSTION OF STOCK*Type: 11P****T-branch and line reduced****T-2X verlopend****Pièce en T 2X réduit****T-2X reduziert**

Article number	Bag / Box	Type
11P-181616	10 pc. / 50 pc.	18x16x16
11P-201616	10 pc. / 50 pc.	20x16x16
11P-201818	10 pc. / 50 pc.	20x18x18
11P-202016	10 pc. / 50 pc.	20x20x16
11P-261620	5 pc. / 30 pc.	26x16x20
11P-262020	5 pc. / 30 pc.	26x20x20
11P-262616	5 pc. / 30 pc.	26x26x16
11P-262620	5 pc. / 30 pc.	26x26x20
11P-322026 *	5 pc. / 20 pc.	32x20x26
11P-322626 *	5 pc. / 20 pc.	32x26x26

TILL EXHAUSTION OF STOCK*Type: 12P****T-enlarged branch****T-vergroot****Pièce en T agrandi****T-erweitert**

Article number	Bag / Box	Type
12P-161816	10 pc. / 60 pc.	16x18x16
12P-162016	10 pc. / 60 pc.	16x20x16
12P-202620	5 pc. / 30 pc.	20x26x20
12P-263226 *	5 pc. / 20 pc.	26x32x26

**TILL EXHAUSTION OF STOCK*

**Type: 13P****T-female centre branch****T-binnendraad****Pièce en T femelle****T-IG**

Article number	Bag / Box	Type
13P-160416	10 pc. / 60 pc.	16x1/2"x16
13P-200420	10 pc. / 50 pc.	20x1/2"x20
13P-200520	10 pc. / 30 pc.	20x3/4"x20
13P-260426	5 pc. / 30 pc.	26x1/2"x26
13P-260526	5 pc. / 30 pc.	26x3/4"x26
13P-320532 *	5 pc. / 20 pc.	32x3/4"x32
13P-320632 *	5 pc. / 20 pc.	32x1"x32
13P-320732 *	5 pc. / 20 pc.	32x1 1/4"x32

TILL EXHAUSTION OF STOCK*Type: 14P****T-male centre branch****T-buitendraad****Pièce en T mâle****T-AG**

Article number	Bag / Box	Type
14P-160416	10 pc. / 60 pc.	16x1/2"x16
14P-200420	10 pc. / 60 pc.	20x1/2"x20
14P-200520	5 pc. / 30 pc.	20x3/4"x20
14P-260426	5 pc. / 30 pc.	26x1/2"x26
14P-260526	5 pc. / 30 pc.	26x3/4"x26
14P-260626	5 pc. / 30 pc.	26x1"x26
14P-320532 *	5 pc. / 20 pc.	32x3/4"x32
14P-320632 *	5 pc. / 20 pc.	32x1"x32

TILL EXHAUSTION OF STOCK*Type: 15P****Straight coupling****Doorverbinder recht / perssok****Manchon****Kupplung**

Article number	Bag / Box	Type
15P-1414	10 pc. / 200 pc.	14x14
15P-1616	10 pc. / 200 pc.	16x16
15P-1818	10 pc. / 150 pc.	18x18
15P-2020	10 pc. / 140 pc.	20x20
15P-2626	5 pc. / 80 pc.	26x26
15P-3232	5 pc. / 50 pc.	32x32



Type: 16P



Reducing coupling

Verloopstuk

Réduction

Kupplung-reduziert

Article number	Bag / Box	Type
16P-1614	10 pc. / 150 pc.	16x14
16P-1816	10 pc. / 150 pc.	18x16
16P-2016	10 pc. / 150 pc.	20x16
16P-2018	10 pc. / 150 pc.	20x18
16P-2616	5 pc. / 100 pc.	26x16
16P-2620	5 pc. / 80 pc.	26x20
16P-3216 *	5 pc. / 60 pc.	32x16
16P-3220 *	5 pc. / 60 pc.	32x20
16P-3226	5 pc. / 60 pc.	32x26

**TILL EXHAUSTION OF STOCK*

Type: 17P



Straight male adapter

Recht aansluitstuk buitendraad / Puntstuk

Raccord droit mâle

Übergangsfitting AG

Article number	Bag / Box	Type
17P-1403	10 pc. / 250 pc.	14x3/8"
17P-1404	10 pc. / 150 pc.	14x1/2"
17P-1603	10 pc. / 150 pc.	16x3/8"
17P-1603DZR	10 pc. / 150 pc.	16x3/8"
17P-1604	10 pc. / 150 pc.	16x1/2"
17P-1604DZR	10 pc. / 150 pc.	16x1/2"
17P-1605	10 pc. / 150 pc.	16x3/4"
17P-1605L		
17P-1804	10 pc. / 150 pc.	18x1/2"
17P-1805	10 pc. / 150 pc.	18x3/4"
17P-2004	10 pc. / 150 pc.	20x1/2"
17P-2005	10 pc. / 150 pc.	20x3/4"
17P-2605	5 pc. / 80 pc.	26x3/4"
17P-2606	5 pc. / 80 pc.	26x1"
17P-3206	5 pc. / 50 pc.	32x1"
17P-3207 *	5 pc. / 40 pc.	32x1 1/4"

**TILL EXHAUSTION OF STOCK*



Type: 18P



Straight female adapter
Recht aansluitstuk binnendraad / Schroefbus
Raccord droit femelle
Übergangsfitting IG

Article number	Bag / Box	Type
18P-1404	10 pc. / 200 pc.	14x1/2"
18P-1604	10 pc. / 150 pc.	16x1/2"
18P-1804	10 pc. / 120 pc.	18x1/2"
18P-1805	10 pc. / 100 pc.	18x3/4"
18P-2004	10 pc. / 100 pc.	20x1/2"
18P-2005	10 pc. / 100 pc.	20x3/4"
18P-2605	5 pc. / 80 pc.	26x3/4"
18P-2606	5 pc. / 70 pc.	26x1"
18P-3206	5 pc. / 50 pc.	32x1"
18P-3207 *	5 pc. / 30 pc.	32x1 1/4"

**TILL EXHAUSTION OF STOCK*

Type: 19P



Press-fit adapter to eurocone
Aansluiting met wartel en euroconus-koppeling
Raccordement avec raccord à visser eurocone
Anschlussverschraubung mit Eurokonus

Article number	Bag / Box	Type
19P-1405	10 pc. / 150 pc.	14x3/4"
19P-1605	10 pc. / 150 pc.	16x3/4"
19P-1805	10 pc. / 150 pc.	18x3/4"
19P-2005	10 pc. / 140 pc.	20x3/4"

Type: 20P



Fitting short model for plint-heating
Fitting laag model voor plintverwarming
Raccord pour montage dans la plinthe
Sockelleisten- Anschluss-Set kurz von unten

Article number	Bag / Box	Type
20P-1604	2 pc. / 10 pc.	16x1/2"

TILL EXHAUSTION OF STOCK

Type: 21P



Elbow for plinth heating chrome-plated
Bocht voor plintverwarming verchromd
Equerre chromée pour montage dans la plinthe
Sockelleistenanschluss Winkel verchromt

Article number	Bag / Box	Type
21P-1504	2 pc. / 40 pc.	15x1/2"



Type: 22P



T, radiator connection nickel-plated 300 mm copper pipe Ø15
 Radiatoraansluiting T vernikkeld met 300 mm koperbuis Ø15
 T, alimentation radiateur nickelé 300 mm tube de cuivre Ø15
 Heizkörperanschlusss T vernickelt 300 mm Kupferrohr Ø15

Article number	Bag / Box	Type
22P-1604	2 pc. / 50 pc.	16x15Cux16
22P-2004	2 pc. / 30 pc.	20x15Cux20

Type: 24P



Radiator connection nickel-plated 300 mm copper pipe Ø15
 Radiatoraansluitbocht vernikkeld met 300 mm koperbuis Ø15
 Alimentation radiateur nickelé 300 mm tube de cuivre Ø15
 Heizkörperanschluss vernickelt 300 mm Kupferrohr Ø15

Article number	Bag / Box	Type
24P-1604	2 pc. / 50 pc.	16x15Cu
24P-2004	2 pc. / 50 pc.	20x15Cu

Type: 25P



Radiator connection nickel-plated 1100 mm copper pipe Ø15
 Radiatoraansluitbocht vernikkeld met 1100 mm koperbuis Ø15
 Alimentation radiateur nickelé 1100 mm tube de cuivre Ø15
 Heizkörperanschluss vernickelt 1100 mm Kupferrohr Ø15

Article number	Tasche	Type
25P-1604	2 pc.	16x15Cu
25P-2004	2 pc.	20x15Cu

Type: 26P



Union with flat seat
 3-delige koppeling vlak dichtend
 Raccord union à joint plat
 Verschraubung flachdichtend

Article number	Bag / Box	Type
26P-1604	10 pc. / 100 pc.	16x1/2"
26P-1605	10 pc. / 80 pc.	16x3/4"
26P-2004	10 pc. / 80 pc.	20x1/2"
26P-2005	10 pc. / 70 pc.	20x3/4"
26P-2605	5 pc. / 50 pc.	26x3/4"
26P-2606	5 pc. / 40 pc.	26x1"
26P-3206	5 pc. / 40 pc.	32x1"



Type: 26P-Z



Press fitting swivel adapter
Aansluiting met wartel, vlakke dichting
Raccord à visser, joint plat
Pressfitting mit IG flachdichtend ohne Nippel

Article number	Bag / Box	Type
26P-14Z04	10 pc. / 150 pc.	14x1/2"
26P-16Z03	10 pc. / 150 pc.	16x3/8"
26P-16Z04	10 pc. / 150 pc.	16x1/2"
26P-16Z05	10 pc. / 80 pc.	16x3/4"
26P-20Z04	10 pc. / 150 pc.	20x1/2"
26P-20Z05	10 pc. / 70 pc.	20x3/4"
26P-26Z05	5 pc. / 50 pc.	26x3/4"
26P-26Z06	5 pc. / 40 pc.	26x1"
26P-32Z06	5 pc. / 40 pc.	32x1"
26P-32Z07	5 pc. / 40 pc.	32x1 1/4"

Type: N



Nipple for 26P-Z
Nippel voor 26P-Z
Nipple pour 26P-Z
Nippel für 26P-Z

Article number	Bag / Box	Type
N04	10 pc. / 250 pc.	1/2"x3/4"
N05	10 pc. / 200 pc.	3/4"x3/4"

Type: 27P



45° bend
Bocht 45°
Coude 45°
Winkel 45°

Article number	Bag / Box	Type
27P-2626	5 pc. / 50 pc.	26x26
27P-3232	5 pc. / 30 pc.	32x32

Type: 28P



Double backplate elbow female, build-up
Dubbele muurplaat binnendraad, opbouw
Culasse double pour sanitaire femelle
Sanitär Wandscheibe doppelt IG, Oberbau

Article number	Bag / Box	Type
28P-14041604-1	1 pc. / 20 pc.	14x1/2"x16x1/2" (153 mm)
28P-16041604-1	1 pc. / 20 pc.	16x1/2"x16x1/2" (153 mm)

**Type: 28PV**

Double backplate elbow female, build-in
Dubbele muurplaat binnendraad, inbouw
Culasse double surélevé
Wandwinkel doppelt erhöht

Article number	Bag / Box	Type
28PV-16031603-1	1 pc. / 15 pc.	16x3/8"x16x3/8" (120 mm)
28PV-16041604-1	1 pc. / 15 pc.	16x1/2"x16x1/2" (153 mm)

Type: 28PF

Double backplate elbow female for plaster
Dubbel muurplaat binnendraad voor gips
Culasse double femelle pour plâtre
Wandscheibe doppelt IG für Gips

Article number	Bag / Box	Type
28PF-16041604	1 pc. / 1 pc.	16x1/2"x16x1/2"
28PF-20042004	1 pc. / 1 pc.	20x1/2"x20x1/2"

Type: 29P-CS (CW724)

Press-fit adapter with copper pipe
Persfitting verlengd met koperbuis
Manchon à sertir avec tube en cuivre
Pressfitting mit Kupferrohr

Article number	Bag / Box	Type
29P-1612-CS	10 pc. / 120 pc.	16x12 (50mm copper)
29P-1615-CS	10 pc. / 120 pc.	16x15 (50mm copper)
29P-2018-CS	10 pc. / 70 pc.	20x18 (50mm copper)
29P-2022-CS	10 pc. / 70 pc.	20x22 (50mm copper)
29P-2622-CS	10 pc. / 70 pc.	26x22 (50mm copper)

Type: 30P

Press-fit adapter to copper compression
Overgangsstuk Henco pers x koperbuis knelkoppeling
Manchon à sertir x tube en cuivre manchon à visser
Pressfitting x Klemmverbinder für Kupferrohr

Article number	Bag / Box	Type
30P-1614S	10 pc. / 120 pc.	16x14 Cu
30P-1615S-2	2 pc. / 100 pc.	16x15 Cu
30P-2022S	10 pc. / 100 pc.	20x22 Cu
30P-2622S	10 pc. / 80 pc.	26x22 Cu

**Type: 31P**

Double crossover tee, nickel plated
Kruisingsvrij T-stuk, vernikkeld
Double T croisé, étamé
Kreuzungs-T-Stück, vernickelt

Article number	Bag / Box	Type
31P-161616	1 pc. / 20 pc.	16x16x16
31P-161620	1 pc. / 20 pc.	16x16x20
31P-201616	1 pc. / 20 pc.	20x16x16
31P-201620	1 pc. / 20 pc.	20x16x20
31P-202020	1 pc. / 20 pc.	20x20x20

Type: ISO-BOX

Insulation box for double crossover tee
Isolatiebox voor kruisingsvrij T-Stuk
Boîte d'isolation pour T croisé
Isolierboxen für Kreuzungs-T-Stück

Article number	Box	Type
ISO-BOX	1 pc.	INSULATION BOX

Type: 33P

Nickel plated press-fit adapter to eurocone, 90°
Aansluiting met wartel en euroconus-koppeling vernikkeld, 90°
Raccord à visser eurocone nickelé, 90°
Anschlussverschraubung mit Eurokonus vernickelt, 90°

Article number	Bag / Box	Type
33P-1605	10 pc. / 60 pc.	16x3/4"

Type: 34P

Henco press swivel adapter with flat sealing, 90°
Aansluiting met wartel vlakdichtend, 90°
Raccord à visser joint plat, 90°
Anschlussverschraubung mit AG flachdichtend, 90°

Article number	Bag / Box	Type
34P-1604	10 pc. / 120 pc.	16x1/2"
34P-1605	10 pc. / 120 pc.	16x3/4"
34P-3206	5 pc. / 40 pc.	32x1"

TILL EXHAUSTION OF STOCK

Type: 34P-CS (CW724)



Henco press swivel adapter with flat sealing, 90°

Aansluiting met wartel vlakdichtend, 90°

Raccord à visser joint plat, 90°

Anschlussverschraubung mit AG flachdichtend, 90°

Article number	Bag / Box	Type
34P-1605-CS	10 pc. / 120 pc.	16x3/4"
34P-2004-CS	10 pc. / 80 pc.	20x2"
34P-2005-CS	10 pc. / 80 pc.	20x3/4"
34P-2605-CS	10 pc. / 70 pc.	26x3/4"

Type: 35P



Press-fit adapter to copper press (M-profile)

Overgangsstuk Henco pers naar koper pers (M-profiel)

Manchon à sertir vers cuivre à sertir (profil M)

Pressfitting Henco zu Pressfitting für Kupferrohr (M-profile)

Article number	Bag / Box	Type
35P-1615P	10 pc. / 150 pc.	16x15Cu M-profile
35P-2018P	10 pc. / 120 pc.	20x18Cu M-profile
35P-2022P	10 pc. / 80 pc.	20x22Cu M-profile
35P-3228P	5 pc. / 50 pc.	32x28Cu M-profile

TILL EXHAUSTION OF STOCK

Type: 36P (CW724)



Press-fit adapter to copper press or thin steel (V, M & SA-profile)

Overgangsstuk Henco pers naar koper pers of dunwandig staal (V, M & SA-profiel)

Manchon à sertir vers cuivre à sertir (profil M, V & SA)

Pressfitting Henco zu Pressfitting für Kupferrohr oder dünnwandig Stahl (Presskontur M, V & SA)

Article number	Bag / Box	Type
36P-1612P	10 pc. / 160 pc.	16x12Cu
36P-1614P	10 pc. / 150 pc.	16x14Cu
36P-1615P	10 pc. / 150 pc.	16x15Cu
36P-1616P	10 pc. / 150 pc.	16x16Cu
36P-2015P	10 pc. / 120 pc.	20x15Cu
36P-2018P	10 pc. / 120 pc.	20x18Cu
36P-2022P	10 pc. / 80 pc.	20x22Cu
36P-2620P	10 pc. / 70 pc.	20x20Cu
36P-2622P	10 pc. / 70 pc.	26x22Cu
36P-2628P	10 pc. / 70 pc.	26x28Cu
36P-3228P	5 pc. / 50 pc.	32x28Cu

Type: 37P

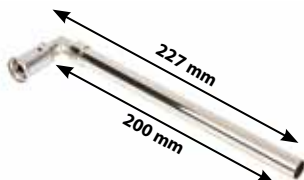

Press-fit adapter to copper pipe, elbow

Persfitting verlengd met koperbuis, knie

Coude à sertir avec tube en cuivre soudé

Pressfitting mit geschweisstem Kupferrohr, Winkel

Article number	Bag / Box	Type
37P-1412L	10 pc. / 60 pc.	14x12 (227/200mm)
37P-1612L	10 pc. / 60 pc.	16x12 (227/200mm)
37P-1615L	10 pc. / 60 pc.	16x15 (227/200mm)



Type: 39P



Double bend for radiator nickel-plated 300 mm copper pipe Ø15, connected end
 Dubbele radiatorbocht koperbuis Ø15, 300 mm, vernikkeld, doorverbonden einde
 Double courbe radiateur nickelé 300 mm tube en cuivre, bout rattaché
 Doppelter Heizkörperwinkel vernickelt 300 mm Kupferrohr Ø15, durchgestelltes Ende

Article number	Bag / Box	Typ
39P-160450	1 pc. / 8 pc.	16x1/2" (AS = 50 mm)

Interaxis 50 mm

Type: 40P



Press-fit elbow to copper compression
 Knie Henco pers x koperbuis knelkoppeling
 Coude à sertir x tube en cuivre manchon à visser, 90°
 Winkel Henco Press x Klemmverbinder für Kupferrohr

Article number	Bag / Box	Type
40P-1615S	10 pc. / 60 pc.	16x15 Cu
40P-2022S	10 pc. / 60 pc.	20x22 Cu
40P-2622S	10 pc. / 60 pc.	26x22 Cu

Type: 41P



Brass press coupling with valve F-connection
 Messing perskoppeling met F-aansluiting
 Connecteur F à sertir
 Pressfittung mit F-Connection

Article number	Bag / Box	Type
41P-16	10 pc. / 40 pc.	16
41P-20	10 pc. / 40 pc.	20
41P-26	10 pc. / 40 pc.	26

BA-F41
(p. 109)

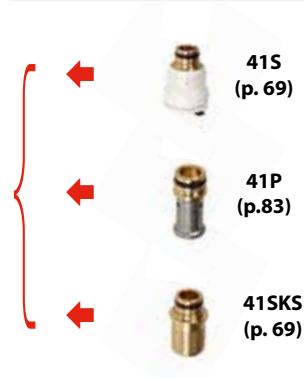

Type: 42P



Straight coupling PEX
 Doorverbinder recht PEX
 Manchon PEX
 Kupplung PEX

Article number	Bag / Box	Type
42P-161615	10 pc. / 200 pc.	16x16x15
42P-202019	10 pc. / 140 pc.	20x20x19

Type: 43P



T-piece Henco press 16 x compression 15 x Henco press 16
 T-stuk Henco pers 16 x koper knel 15 x Henco pers 16
 Pièce en T Henco sertir 16 x manchon à visser 15 x Henco sertir 16
 T-Stuck Henco Press 16 x Klemmverbinder 15 x Henco Press 16

Article number	Bag / Box	Type
43P-161516	2 pc. / 50 pc.	16x15x16

Type: 52P



Easy mounting/repair fitting
 Eenvoudige montage/reparatie fitting
 Raccord montage/réparation facile
 Einfache Montage/Reparatur Fitting

Article number	Bag / Box	Type
52P16	1 pc. / 40 pc.	16x16
52P20	1 pc. / 30 pc.	20x20
52P26	1 pc. / 30 pc.	26x26
52P32	1 pc. / 30 pc.	32x32

for Ø40, 50 and 63: chapter 2, article 53PK

Type: WALL BOX

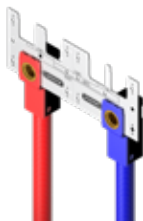

Wall box 2 pair red/blue, 1/2"Fx16mm
 Wall box 2 paar rood/blauw, 1/2"Fx16mm
 Wall box 2 paires rouge/bleu, 1/2"Fx16mm
 Wall box 2 Paare red/blau, 1/2"Fx16mm

Article number	Bag / Box	Type
WBP-1604	1 pc. / 40 pc.	16x1/2"
WBP-2004	1 pc. / 40 pc.	20x1/2"



Instruction video

Type: 17VBS



Straight adapter VBS manifold
 Recht aansluitstuk VBS verdeler
 Raccord droit VBS collecteur
 Gerades Verbindungsstück AG VBS Verteiler

Article number	pc / Box	Type
17VBS-2005	10/150	20mmx3/4"
17VBS-2605	5/80	26mmx3/4"
17VBS-2606	5/80	26mmx1"

Article 17VBS to be used in combination with the VBS manifold, see page 105



Gas: only allowed in countries where has been a HENCO GAS testing + certificate is available! (See www.henco.be)
 Gas: enkel toegelaten in landen waar er een HENCO GAS keur is + certificaat voorhanden is! (Zie www.henco.be)
 Gaz: seulement permis dans des pays où le contrôle a eu lieu + certificat est disponible! (Consultez www.henco.be)
 Gas: nur zugelassen in Länder wo HENCO GAS Prüfung geschehen ist + Zertifikat vorhanden ist! (Siehe www.henco.be)

Henco brass press fittings for gas in combination with standard pipes gas, see page 19



Type: 1PG



Elbow 90°
 Knie 90°
 Coude 90°
 Winkel 90°

Article number	Bag / Box	Type
1PG-1616	10 pc. / 150 pc.	16x16
1PG-2020	10 pc. / 80 pc.	20x20
1PG-2626	5 pc. / 50 pc.	26x26
1PG-3232	5 pc. / 50 pc.	32x32

Type: 2PG



Backplate elbow female
 Muurplaat binnendraad
 Culasse femelle
 Wandscheibe IG

Article number	Bag / Box	Type
2PG-1604	10 pc. / 50 pc.	16x1/2" (52 mm)
2PG-2004	10 pc. / 50 pc.	20x1/2" (52 mm)
2PG-2005	10 pc. / 50 pc.	20x3/4" (52mm)
2PG-2605	5 pc. / 50 pc.	26x3/4" (52 mm)

Type: 2PG-K



Backplate elbow female, short model
 Muurplaat binnendraad, laag
 Culasse femelle, modèle court
 Wandscheibe IG, kurzes Modell

Article number	Bag / Box	Type
2PG-1604K	10 pc. / 50 pc.	16x1/2" (35 mm)

Type: 3PG



Double backplate elbow female
 Muurplaat binnendraad dubbel
 Culasse double
 Wandscheibedoppelt IG

Article number	Bag / Box	Type
3PG-160416	10 pc. / 50 pc.	16x1/2"x16 (52 mm)
3PG-200420	10 pc. / 40 pc.	20x1/2"x20 (52 mm)



B. PG

Type: 5PG



Elbow 90° male adapter
 Knie 90° buitendraad
 Coude 90° mâle
 Winkel 90° AG

Article number	Bag / Box	Type
5PG-1604	10 pc. / 150 pc.	16x1/2"
5PG-2004	10 pc. / 100 pc.	20x1/2"
5PG-2005	10 pc. / 80 pc.	20x3/4"
5PG-2605	10 pc. / 60 pc.	26x3/4"

Type: 6PG



Elbow 90° female adapter
 Knie 90° binnendraad
 Coude 90° femelle
 Winkel 90° IG

Article number	Bag / Box	Type
6PG-1604	10 pc. / 120 pc.	16x1/2"
6PG-2004	10 pc. / 120 pc.	20x1/2"
6PG-2005	10 pc. / 50 pc.	20x3/4"
6PG-2605	5 pc. / 50 pc.	26x3/4"

Type: 9PG



T-piece
 T-stuk
 Pièce en T
 T-Stück

Article number	Bag / Box	Type
9PG-161616	10 pc. / 60 pc.	16x16x16
9PG-202020	10 pc. / 50 pc.	20x20x20
9PG-323232 *	1 pc. / 20 pc.	32x32x32

*TILL EXHAUSTION OF STOCK

Type: 10PG



T-reduced centre
 T-verlopend
 Pièce en T-réduit
 T-reduziert

Article number	Bag / Box	Type
10PG-262026	5 pc. / 30 pc.	26x20x26

Type: 11PG



T-branch and line reduced
 T-2X verlopend
 Pièce en T 2X réduit
 T-2X reduziert

Article number	Bag / Box	Type
11PG-201616	10 pc. / 50 pc.	20x16x16



Type: 13PG



T-female centre
T-binnendraad
Pièce en T femelle
T-IG

Article number	Bag / Box	Type
13PG-200420	10 pc. / 50 pc.	20x1/2"x20
13PG-260426	5 pc. / 30 pc.	26x1/2"x26
13PG-260526	5 pc. / 30 pc.	26x3/4"x26

Type: 15PG



Straight coupling
Doorverbinder recht / perssok
Manchon
Kupplung

Article number	Bag / Box	Type
15PG-1616	10 pc. / 200 pc.	16x16
15PG-2020	10 pc. / 140 pc.	20x20
15PG-2626	5 pc. / 80 pc.	26x26
15PG-3232	5 pc. / 50 pc.	32x32

Type: 16PG



Reducing coupling
Verloopstuk
Réduction
Kupplung-reduziert

Article number	Bag / Box	Type
16PG-2016	10 pc. / 150 pc.	20x16
16PG-2620	5 pc. / 80 pc.	26x20
16PG-3226	5 pc. / 40 pc.	32x26

Type: 17PG



Straight male adapter
Recht aansluitstuk buitendraad / Puntstuk
Raccord droit mâle
Übergangsfitting AG

Article number	Bag / Box	Type
17PG-1604	10 pc. / 150 pc.	16x1/2"
17PG-2004	10 pc. / 150 pc.	20x1/2"
17PG-2005	10 pc. / 150 pc.	20x3/4"
17PG-2605	5 pc. / 80 pc.	26x3/4"
17PG-2606	5 pc. / 80 pc.	26x1"
17PG-3206	5 pc. / 50 pc.	32x1"

- 1
- 2
- 3
- 4
- 5
- 6
- 7
- 8
- 9
- 10
- 11



B. PG

Type: 18PG



Straight female adapter
Recht aansluitstuk binnendraad / Schroefbus
Raccord droit femelle
Übergangsfitting IG

Article number	Bag / Box	Type
18PG-1604	10 pc. / 150 pc.	16x1/2"
18PG-2004	10 pc. / 100 pc.	20x1/2"
18PG-2005	10 pc. / 100 pc.	20x3/4"
18PG-2605	5 pc. / 80 pc.	26x3/4"
18PG-2606	5 pc. / 50 pc.	26x1"
18PG-3206	5 pc. / 50 pc.	32x1"

Type: 30PG



Press-fit adapter to copper compression
Overgangsstuk Henco pers x koperbuis knelkoppeling
Manchon henco à sertir x tube de cuivre manchon à visser
Pressfitting x Klemmverbinder für Kupferrohr

Article number	Bag / Box	Type
30PG-1615S-2	10 pc. / 120 pc.	16x15 Cu
30PG-2022S	10 pc. / 100 pc.	20x22 Cu
30PG-2622S	10 pc. / 80 pc.	26x22 Cu

Type: 36PG



Press-fit adapter to copper press (V, M & SA-profile)
Overgangsstuk Henco pers naar koper pers (V, M & SA-profiel)
Manchon à sertir vers cuivre à sertir (profil M, V & SA)
Pressfitting Henco zu Pressfitting für Kupferrohr (Presskontur M, V & SA)

Article number	Bag / Box	Type
36PG-1615P	10 pc. / 150 pc.	16x15Cu
36PG-2015P	10 pc. / 120 pc.	20x15Cu
36PG-2022P	10 pc. / 80 pc.	20x22Cu
36PG-2615P	10 pc. / 80 pc.	26x15Cu
36PG-2622P	10 pc. / 70 pc.	26x22Cu





Type: 1



Straight male adapter
Recht aansluitstuk buitendraad / Puntstuk
Raccord droit mâle
Kupplung AG

Article number	Bag / Box	Type
1-1403C *	10 pc. / 250 pc.	14x3/8" + o-ring
1-1404	10 pc. / 250 pc.	14x1/2" + o-ring
1-1604	10 pc. / 180 pc.	16x1/2" + o-ring
1-1604Z	10 pc. / 250 pc.	16x1/2"
1-1605	10 pc. / 150 pc.	16x3/4"
1-1804	10 pc. / 150 pc.	18x1/2" + o-ring
1-1805 **	10 pc. / 150 pc.	18x3/4"
1-2004	10 pc. / 150 pc.	20x1/2" + o-ring
1-2004Z	10 pc. / 150 pc.	20x1/2"
1-2005	10 pc. / 150 pc.	20x3/4"
1-2605	5 pc. / 80 pc.	26x3/4"
1-2606	5 pc. / 80 pc.	26x1"
1-3206	5 pc. / 80 pc.	32x1"

* FOR FUEL OIL

** TILL EXHAUSTION OF STOCK

Type: 2



Straight coupling
Doorverbinder recht
Manchon
Kupplung doppelt

Article number	Bag / Box	Type
2-1616	10 pc. / 200 pc.	16x16
2-2020	10 pc. / 120 pc.	20x20
2-2626 *	5 pc. / 60 pc.	26x26
2-3232 *	5 pc. / 40 pc.	32x32

* TILL EXHAUSTION OF STOCK

Type: 3



Straight female adapter
Recht aansluitstuk binnendraad / Schroefbus
Raccord droit femelle
Kupplung IG

Article number	Bag / Box	Type
3-1403C * **	10 pc. / 200 pc.	14x3/8"
3-1404 **	10 pc. / 200 pc.	14x1/2"
3-1604	10 pc. / 170 pc.	16x1/2"
3-1804	10 pc. / 120 pc.	18x1/2"
3-2004	10 pc. / 120 pc.	20x1/2"
3-2005	10 pc. / 120 pc.	20x3/4"
3-2605	5 pc. / 80 pc.	26x3/4"
3-2606	5 pc. / 80 pc.	26x1"
3-3206 **	5 pc. / 80 pc.	32x1"

* FOR FUEL OIL

** TILL EXHAUSTION OF STOCK



Type: 4



Elbow 90°
Knie 90°
Coude 90°
Winkel 90°

Article number	Bag / Box	Type
4-1414 *	10 pc. / 150 pc.	14x14
4-1616	10 pc. / 110 pc.	16x16
4-2020	10 pc. / 60 pc.	20x20
4-2626	10 pc. / 40 pc.	26x26
4-3232 *	5 pc. / 32 pc.	32x32

* TILL EXHAUSTION OF STOCK

Type: 5



Elbow 90° male adapter
Knie 90° buitendraad
Coude 90° mâle
Winkel 90° AG

Article number	Bag / Box	Type
5-1604	10 pc. / 150 pc.	16x1/2"
5-1804 *	10 pc. / 100 pc.	18x1/2"
5-2005	10 pc. / 100 pc.	20x3/4"
5-2606	5 pc. / 40 pc.	26x1"
5-3206 *	5 pc. / 40 pc.	32x1"

* TILL EXHAUSTION OF STOCK

Type: 6



Elbow 90° female adapter
Knie 90° binnendraad
Coude 90° femelle
Winkel 90° IG

Article number	Bag / Box	Type
6-1404 *	10 pc. / 150 pc.	14x1/2"
6-1604	10 pc. / 150 pc.	16x1/2"
6-1804 *	10 pc. / 90 pc.	18x1/2"
6-2004 *	10 pc. / 80 pc.	20x1/2"
6-2005	10 pc. / 80 pc.	20x3/4"
6-2605 *	5 pc. / 50 pc.	26x3/4"
6-2606 *	5 pc. / 30 pc.	26x1"
6-3206 *	5 pc. / 40 pc.	32x1"

* TILL EXHAUSTION OF STOCK

- 1
- 2
- 3
- 4
- 5
- 6
- 7
- 8
- 9
- 10
- 11



Type: 7



Backplate elbow with branch connection

Sanitair muurplaat binnendraad

Culasse pour sanitaire femelle

Sanitär Wandscheibe

Article number	Bag / Box	Type
7-1404 *	10 pc. / 80 pc.	14x1/2"
7-1604	10 pc. / 80 pc.	16x1/2"
7-2004	10 pc. / 60 pc.	20x1/2"

** TILL EXHAUSTION OF STOCK*

Type: 7D



Double backplate elbow with branch connection

Sanitair muurplaat binnendraad dubbel

Culasse pour sanitaire femelle double

Sanitär Wandscheibe doppelt

Article number	Bag / Box	Type
7-160416	10 pc. / 50 pc.	16x1/2"x16

TILL EXHAUSTION OF STOCK

Type: 8



T-piece

T-stuk

Piece en T

T-Stück

Article number	Bag / Box	Type
8-161616	10 pc. / 70 pc.	16x16x16
8-181818 *	10 pc. / 50 pc.	18x18x18
8-202020	10 pc. / 50 pc.	20x20x20

** TILL EXHAUSTION OF STOCK*



Type: 9



T-female branch
T-binnendraad
Pièce en T femelle
T-IG

Article number	Bag / Box	Type
9-140414 *	10 pc. / 80 pc.	14x1/2"x14
9-160416	10 pc. / 80 pc.	16x1/2"x16
9-200420 *	10 pc. / 40 pc.	20x1/2"x20
9-200520	10 pc. / 40 pc.	20x3/4"x20
9-260526 *	5 pc. / 30 pc.	26x3/4"x26

* TILL EXHAUSTION OF STOCK

Type: 10



Nut, insert and jointing ring
Moer, Insert en klemring
Ecrou, insert et bicône
Mutter, Stutzhülse und Klemmring

Article number	Bag / Box	Type
10-1604SN	10 pc. / 300 pc.	16x1/2"

TILL EXHAUSTION OF STOCK

Type: 11



T-male branch
T-buitendraad
Pièce en T mâle
T-AG

Article number	Bag / Box	Type
11-200420 *	10 pc. / 70 pc.	20x1/2"x20
11-260526 *	5 pc. / 30 pc.	26x3/4"x26
11-260626 *	5 pc. / 30 pc.	26x1"x26

* TILL EXHAUSTION OF STOCK

Type: 13-2



Nut, insert and jointing ring to copper compression
Adapter Henco buis naar messing knelverbinding
Raccord à visser cuivre vers multicouche
Verbindungsstück Kupfer Schraubfitting auf Henco

Article number	Bag / Box	Type
13-1415-2 *	2 pc. / 200 pc.	14x15 Cu
13-1615A-2 *	2 pc. / 200 pc.	16x15 Cu
13-1615HA-2	2 pc. / 200 pc.	16x15 Cu
13-2022HA-2	2 pc. / 120 pc.	20x22 Cu
13-2628H-2	2 pc. / 80 pc.	26x28 Cu

* Nickel plated nut



Type: 13-VH



Adapter for Henco compression 26mm to copper compression 22mm
 Adapter Henco buis 26mm naar messing knelverbinding 22mm
 Adapteur raccord à visser cuivre 22mm vers multicouche 26mm
 Verbindungsstück für Henco Schraubfitting 26mm auf Kupfer Schraubfitting 22mm

Article number	Bag / Box	Type
13-V2622H-2	2 pc. / 70 pc.	26x22 Cu

Type: 24



Compression coupling Henco x copper tube
 Overgangsstuk Henco knel x koperbuis knelverbinding
 Raccord droit Henco x tube de cuivre manchon à visser
 Gerade Fitting Henco x Klemmverbinder für Kupferrohr

Article number	Bag / Box	Type
24-1615-S	10 pc. / 200 pc.	16x15 Cu
24-2022	10 pc. / 100 pc.	20x22 Cu
24-2622	5 pc. / 50 pc.	26x22 Cu
24-2628	5 pc. / 50 pc.	26x28 Cu

Type: 28



T-reduced centre
 T-verlopend
 Pièce en T réduit
 T-reduziert

Article number	Bag / Box	Type
28-201620	5 pc. / 50 pc.	20x16x20
28-202016 *	5 pc. / 50 pc.	20x20x16
28-262026 *	5 pc. / 30 pc.	26x20x26

**TILL EXHAUSTION OF STOCK*



Type: EK



Nickel plated eurocone (3/4"F)
 Euroconus schroefkoppeling (3/4"F)
 Raccord à visser eurocone (3/4"F)
 Schraubfitting Eurokonus (3/4"F)

Article number	Bag / Box	Type
EK12-2	2 pc. / 100 pc.	Ø12
EK14-2	2 pc. / 100 pc.	Ø14
EK16-2	2 pc. / 100 pc.	Ø16
EK17-2	2 pc. / 100 pc.	Ø17
EK18-2	2 pc. / 100 pc.	Ø18
EK20-2	2 pc. / 100 pc.	Ø20

Type: EKH



Brass eurocone (3/4"F)
 Euroconus-schroefkoppeling (3/4"F) niet vernikkeld
 Raccord à visser eurocone (3/4"F) laiton non nickelé
 Schraubfitting Eurokonus (3/4"F) Messing nicht vernickelt

Article number	Bag / Box	Type
EKH16-2	2 pc. / 100 pc.	Ø16

Type: EK15



Eurocone (3/4"F) for copper tube 15mm
 Euroconus-schroefkoppeling (3/4"F) voor koperbuis 15mm
 Raccord à visser eurocone (3/4"F) pour tube de cuivre 15mm
 Schraubfitting Eurokonus (3/4") für Kupferrohr 15mm

Article number	Bag / Box	Type
EK15	25 pc. / 400 pc.	Ø15

Type: SPLIT-S



Split ring for compression fittings (not for EK)
 Klemring voor schroeffittingen (niet voor EK)
 Anneau de serrage pour raccords à visser (pas pour EK)
 Klemring für Schraubfitting (nicht für EK)

Article number	Bag	Type
SPLIT-S16	10 pc.	Ø16
SPLIT-S20	10 pc.	Ø20



- 1
- 2
- 3
- 4
- 5
- 6
- 7
- 8
- 9
- 10
- 11

Type: AB



Elbow 90° eurocone elbow (3/4" M)
 Knie 90° voor euroconus-aansluiting (3/4" M)
 Coude 90° pour raccordement eurocone (3/4" M)
 Winkel 90° für Eurokonusanschluß (3/4" M)

Article number	Bag / Box	Type
AB1420	10 pc. / 100 pc.	3/4"x3/4" for EK

Type: ABE



Elbow 90° eurocone (3/4" M) x 1/2" male adapter
 Knie 90° buitendraad 1/2 x euroconus-aansluiting (3/4" M)
 Coude 90° mâle 1/2" x raccordement eurocone (3/4" M)
 Winkel 90° AG 1/2 x Eurokonusanschluss (3/4" M)

Article number	Bag / Box	Type
ABEK04	10 pc. / 150 pc.	1/2"x3/4"

Type: AT



Eurocone equal T
 T voor euroconus-aansluiting (3/4" M)
 Pièce en T pour raccordement eurocone (3/4" M)
 T für Eurokonusanschluß (3/4" M)

Article number	Bag / Box	Type
AT1420	10 pc. / 100 pc.	3/4"x3/4"x3/4"

Type: AD



Eurocone straight coupling (3/4" M)
 Euroconus nippel (3/4" M)
 Mamelon 2x raccordement eurocone (3/4" M)
 Nippel für 2x Eurokonusanschluss

Article number	Bag / Box	Type
AD-EKEK	10 pc. / 250 pc.	3/4"x3/4" for



Type: AN



Straight eurocone connection (3/4" M) to 1/2" male adapter
 Recht overgangsstuk 1/2" M met O-ring en -aansluiting (3/4" M)
 Manchon droit mâle 1/2" avec o-ring et eurocone
 Nippel AG 1/2" mit O-ring und Eurokonusanschluss (3/4" M)

Article number	Bag / Box	Type
AN1420	10 pc. / 250 pc.	1/2"x3/4" for

Type: 3EK



Double backplate elbow female, 2x eurocone connection
 Doorstroom muurplaat binnendraad, 2x euroconus-aansluiting
 Culasse double, 2x raccordement eurocone
 Wandscheibe doppelt IG, 2x Eurokonusanschluss

Article number	Bag / Box	Type
3EK-050405	5 pc. / 40 pc.	3/4"x1/2"x3/4" (50 mm)

Type: WALL BOX



Wall box 2 pair red/blue, 1/2" FX16mm
 Wall box 2 paar rood/blauw, 1/2" FX16mm
 Wall box 2 paires rouge/bleu, 1/2" FX16mm
 Wall box 2 Paare red/blau, 1/2" FX16mm

Article number	Bag / Box	Type.
WBS-1604	1 pc. / 40 pc.	16x1/2"



Instruction video

- 1
- 2
- 3
- 4
- 5
- 6
- 7
- 8
- 9
- 10
- 11

MANIFOLDS - VERDELERS - COLLECTEURS - VERTEILER





Type: V-06

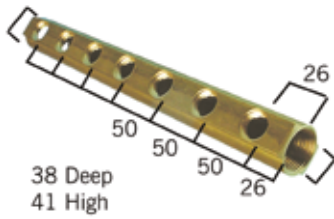

Manifold 1", 1/2" female thread, 3/8" air vent hole
Verdeler 1", 1/2" aansluitingen, 3/8" ontluichtingsopening
Collecteur 1", conn. 1/2" femelle, conn. 3/8" pour purgeur
Verteiler 1", 1/2" IG, 3/8" Loch für Entlüftung

Article number	pc / Box	Type
V-060402	1 pc. / 64 pc.	1" 2x1/2" x 3/8"
V-060403	1 pc. / 48 pc.	1" 3x1/2" x 3/8"
V-060404	1 pc. / 30 pc.	1" 4x1/2" x 3/8"
V-060405	1 pc. / 28 pc.	1" 5x1/2" x 3/8"
V-060406	1 pc. / 20 pc.	1" 6x1/2" x 3/8"
V-060407	1 pc. / 25 pc.	1" 7x1/2" x 3/8"
V-060408	1 pc. / 20 pc.	1" 8x1/2" x 3/8"
V-060409*	1 pc. / 20 pc.	1" 9x1/2" x 3/8"

** TILL EXHAUSTION OF STOCK*

Type: V-05-Z



Manifold 3/4", 1/2" female thread
Verdeler 3/4", 1/2" aansluitingen
Collecteur 3/4", conn. 1/2" femelle
Verteiler 3/4", 1/2" IG

Article number	pc / Box	Type
V-050403-Z	1 pc. / 48 pc.	3/4" 3x1/2"
V-050404-Z	1 pc. / 30 pc.	3/4" 4x1/2"
V-050405-Z	1 pc. / 42 pc.	3/4" 5x1/2"
V-050406-Z*	1 pc. / 20 pc.	3/4" 6x1/2"

** TILL EXHAUSTION OF STOCK*

Type: V-06-Z

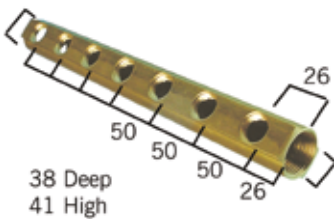

Manifold 1", 1/2" female thread
Verdeler 1", 1/2" aansluitingen
Collecteur 1", conn. 1/2" femelle
Verteiler 1", 1/2" IG

Article number	pc / Box	Type
V-060402-Z	1 pc. / 64 pc.	1" 2x1/2"
V-060408-Z	1 pc. / 20 pc.	1" 8x1/2"

Type: V-07-Z

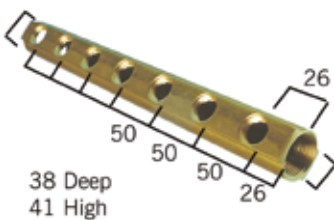

Manifold 5/4", 1/2" female thread
Verdeler 5/4", 1/2" aansluitingen
Collecteur 5/4", conn. 1/2" femelle
Verteiler 5/4", 1/2" IG

Article number	pc / Box	Type
V-070405-Z	1 pc. / 14 pc.	5/4" 5x1/2"
V-070406-Z	1 pc. / 15 pc.	5/4" 6x1/2"
V-070407-Z	1 pc. / 20 pc.	5/4" 7x1/2"
V-070408-Z	1 pc. / 20 pc.	5/4" 8x1/2"
V-070410-Z	1 pc. / 10 pc.	5/4" 10x1/2"



Type: VEK-06



Manifold 1" with connections and one 3/8" air vent hole
Verdeler 1" met EK-aansluitingen en 3/8" ontluichtingsopening
Collecteur 1" avec des raccords eurocone et un trou 3/8" pour purgeur
Verteiler 1" mit -Anschlüssen und 3/8" Loch für Entlüftung

Article number	pc / Box	Type
VEK-060502	1 pc. / 48 pc.	1" 2x3/4" x 3/8"
VEK-060503	1 pc. / 32 pc.	1" 3x3/4" x 3/8"
VEK-060504	1 pc. / 20 pc.	1" 4x3/4" x 3/8"
VEK-060505	1 pc. / 21 pc.	1" 5x3/4" x 3/8"
VEK-060506	1 pc. / 20 pc.	1" 6x3/4" x 3/8"
VEK-060507	1 pc. / 20 pc.	1" 7x3/4" x 3/8"
VEK-060508	1 pc. / 20 pc.	1" 8x3/4" x 3/8"
VEK-060509	1 pc. / 15 pc.	1" 9x3/4" x 3/8"
VEK-060510	1 pc. / 15 pc.	1" 10x3/4" x 3/8"

Type: VEK-06-Z

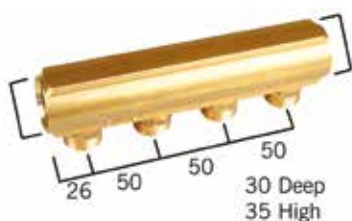

Manifold 1" with eurocone connections
Verdeler 1" met euroconus-aansluitingen
Collecteur 1" avec des raccords eurocone
Verteiler 1" mit Eurokonus-Anschlüssen

Article number	pc / Box	Type
VEK-060502-Z	1 pc. / 48 pc.	1" 2x3/4"
VEK-060503-Z	1 pc. / 32 pc.	1" 3x3/4"
VEK-060504-Z	1 pc. / 20 pc.	1" 4x3/4"
VEK-060505-Z	1 pc. / 21 pc.	1" 5x3/4"
VEK-060506-Z	1 pc. / 20 pc.	1" 6x3/4"
VEK-060507-Z	1 pc. / 20 pc.	1" 7x3/4"
VEK-060508-Z	1 pc. / 20 pc.	1" 8x3/4"
VEK-060509-Z	1 pc. / 15 pc.	1" 9x3/4"
VEK-060510-Z	1 pc. / 15 pc.	1" 10x3/4"

Type: VEK-05-Z

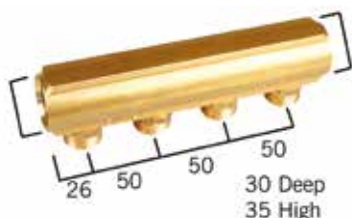

Manifold 3/4" with eurocone connections
Verdeler 3/4" met euroconus-aansluitingen
Collecteur 3/4" avec des raccords eurocone
Verteiler 3/4" mit Eurokonus-Anschlüssen

Article number	pc / Box	Type
VEK-050504-Z	6 pc. / 30 pc.	3/4" 4x3/4"
VEK-050505-Z	4 pc. / 28 pc.	3/4" 5x3/4"
VEK-050507-Z	1 pc. / 25 pc.	3/4" 7x3/4"
VEK-050508-Z	1 pc. / 25 pc.	3/4" 8x3/4"
VEK-050509-Z	1 pc. / 20 pc.	3/4" 9x3/4"



Type: VEK-06-ZV



Manifold 1" with eurocone connections
 Verdeler 1" met euroconus-aansluitingen
 Collecteur 1" avec des raccordements eurocone
 Verteiler 1" mit Eurokonus-Anschlüssen

Article number	pc / Box	Type
VEK-060502-ZV	1 pc. / 8 pc.	1" 2x3/4"

TILL EXHAUSTION OF STOCK

Type: H-0212



Insulated manifold bracket (pairs)
 Ophangbeugel dubbel met isolatie voor alle verdelers
 Support double avec isolation pour tous les collecteurs
 Verteiler-Halter mit Isolierung doppelt für alle Verteiler

Article number	pc / Box	Type
H-0212	1 pc. / 150 pc.	3/4" - 1 - 5/4"

Type: H-0212-S



Insulated manifold bracket (single)
 Ophangbeugel enkel met isolatie voor alle verdelers
 Support simple avec isolation pour tous les collecteurs
 Verteiler-Halter mit Isolierung einfach für alle Verteiler

Article number	pc / Box	Type
H-0212-S	1 pc. / 500 pc.	3/4" - 1" - 5/4"

Type: VS REDUCTIE



Manifold reducer with O-ring
 Reductie met O-ring voor verdeler
 Réduction avec O-ring pour collecteur
 Reduktion für Verteiler mit O-ring

Article number	pc / Box	Type
VS-0504	10 pc. / 500 pc.	3/4"x1/2"
VS-0604	10 pc. / 250 pc.	1"x1/2"
VS-0605	10 pc. / 250 pc.	1"x3/4"

Type: VS BLINDSTOP



Manifold plug with O-ring
 Blindstop met O-ring voor verdeler
 Bouchon avec O-ring pour collecteur
 Stopfen mit O-Ring für Verteiler

Article number	pc / Box	Type
VS-05	10 pc. / 250 pc.	3/4"
VS-06	10 pc. / 200 pc.	1"
VS-07	10 pc. / 200 pc.	5/4"

- 1
- 2
- 3
- 4
- 5
- 6
- 7
- 8
- 9
- 10
- 11



1
2
3
4
5
6

Type: VB-EK05



Ball valve, 2 x eurocone connection
Bolkraan , 2 x euroconus aansluiting
Vanne d'arrêt, 2 x raccordement eurocone
Kugelhahn, 2 x Eurokonus

Article number	Box / Big Box	Type
VB-EK05	25 pc. / 200 pc.	3/4" EK x 3/4" EK

7
8
9
10
11

Type: VR-EK05



Lockshield 2x eurocone connection
Regelkraan 2x euroconus aansluiting
Te de reglage 2x raccordement eurocone
Asperrbare Ventil 2x eurokonus

Article number	Type
VR-EK05	3/4" EK x 3/4" EK

Type: VB05



Manifold 3/4" with ball valves and eurocone connection
Verdeler 3/4" met bolkraan en euroconus-aansluiting
Collecteur 3/4" avec vanne d'arrêt et eurocone
Verteiler 3/4" mit Kugelhahnset und Eurokonus

Article number	pc / Box	Type
VB050502-BLAUW	5 pc. / 50 pc.	3/4"x2xEK14,16,18 & 20
VB050502-ROOD	5 pc. / 50 pc.	3/4"x2xEK14,16,18 & 20
VB050503-BLAUW	5 pc. / 50 pc.	3/4"x3xEK14,16,18 & 20
VB050503-ROOD	5 pc. / 50 pc.	3/4"x3xEK14,16,18 & 20
VB050504-BLAUW	4 pc. / 40 pc.	3/4"x4xEK14,16,18 & 20
VB050504-ROOD	4 pc. / 40 pc.	3/4"x4xEK14,16,18 & 20

Type: VB06



Manifold 1" with ball valves and eurocone connection
Verdeler 1" met bolkraan en euroconus-aansluiting
Collecteur 1" avec vanne d'arrêt et eurocone
Verteiler 1" mit Kugelhahnset und Eurokonus

Article number	pc / Box	Type
VB060502-BLAUW	5 pc. / 50 pc.	1"x2xEK14,16,18 & 20
VB060502-ROOD	5 pc. / 50 pc.	1"x2xEK14,16,18 & 20
VB060503-BLAUW	5 pc. / 40 pc.	1"x3xEK14,16,18 & 20
VB060503-ROOD	5 pc. / 40 pc.	1"x3xEK14,16,18 & 20
VB060504-BLAUW	4 pc. / 40 pc.	1"x4xEK14,16,18 & 20
VB060504-ROOD	4 pc. / 40 pc.	1"x4xEK14,16,18 & 20



Type: VBS05



Manifold 3/4" with valves and eurocone connection
 Verdeler 3/4" met kraan en euroconus-aansluiting
 Collecteur 3/4" avec vanne et eurocone
 Verteiler 3/4" mit Kugelhahnset und Eurokonus

Article number	pc / Box	Type
VBS050502-BL	1 pc. / 20 pc.	3/4"x2xEK14,16,18 & 20
VBS050502-RO	1 pc. / 20 pc.	3/4"x2xEK14,16,18 & 20
VBS050503-BL	1 pc. / 15 pc.	3/4"x3xEK14,16,18 & 20
VBS050503-RO	1 pc. / 15 pc.	3/4"x3xEK14,16,18 & 20
VBS050504-BL	1 pc. / 10 pc.	3/4"x4xEK14,16,18 & 20
VBS050504-RO	1 pc. / 10 pc.	3/4"x4xEK14,16,18 & 20

Type: VBS06



Manifold 1" with valves and eurocone connection
 Verdeler 1" met kraan en euroconus-aansluiting
 Collecteur 1" avec vanne et eurocone
 Verteiler 1" mit Kugelhahnset und Eurokonus

Article number	pc / Box	Type
VBS060502-BL	1 pc. / 20 pc.	1"x2xEK14,16,18 & 20
VBS060502-RO	1 pc. / 20 pc.	1"x2xEK14,16,18 & 20
VBS060503-BL	1 pc. / 15 pc.	1"x3xEK14,16,18 & 20
VBS060503-RO	1 pc. / 15 pc.	1"x3xEK14,16,18 & 20
VBS060504-BL	1 pc. / 10 pc.	1"x4xEK14,16,18 & 20
VBS060504-RO	1 pc. / 10 pc.	1"x4xEK14,16,18 & 20

Type: 17VBS



Straight adapter VBS manifold
 Recht aansluitstuk VBS verdeler
 Raccord droit VBS collecteur
 Gerades Verbindungsstück AG VBS Verteiler

Article number	pc / Box	Type
17VBS-2005	10/150	20mmx3/4"
17VBS-2605	5/80	26mmx3/4"
17VBS-2606	5/80	26mmx1"

Type: VBS



Plug with O-ring VBS Manifold
 Blindstop M met O-ring VBS verdeler
 Bouchon pour VBS collecteur avec O-ring
 Stopf für Verteiler VBS mit O-Ring

Article number	pc / Box	Type
VBS-05	10/250	3/4"
VBS-06	10/250	1"

VALVES - KRANEN - VANNES - VENTILE





Type: RAD04-100V



Radiator connector with 3/4" eurocone connections, straight
 Onderblok met 3/4" euroconus-aansluitingen, recht
 Raccord radiateur, droit, eurocone
 Heizkörperanschluss 1/2" mit 3/4" Eurokonus-Anschlüssen, unten

Article number	Box / Big Box	Type
RAD04-100V	10 pc. / 100 pc.	1/2"x3/4" EK

Type: RAD04-100H



Radiator connector with 3/4" eurocone connections, Elbow
 Onderblok met 3/4" euroconus-aansluitingen, haaks
 Raccord radiateur, équerre, eurocone
 Heizkörperanschluss 1/2" mit 3/4" Eurokonus-Anschlüssen, hinten

Article number	Box / Big Box	Type
RAD04-100H	10 pc. / 100 pc.	1/2"x3/4" EK

TILL EXHAUSTION OF STOCK

Type: EK15



Eurocone (3/4"F) for copper tube 15mm
 Euroconus-schroefkoppeling (3/4"F) voor koperbuis 15mm
 Raccord à visser eurocone (3/4"F) pour tube en cuivre 15mm
 Schraubfitting Eurokonus (3/4") für Kupferrohr 15mm

Article number	Box / Big Box	Type
EK15	25 pc. / 400 pc.	Ø15

Type: RADK2-R



Radiator valve 1/2" with 3/4" eurocone connection, straight
 Radiatorkraan 1/2" met 3/4" euroconus-aansluiting, recht
 Vanne radiateur droite 1/2" avec raccordement
 Heizkörperventil 1/2" mit 3/4" Eurokonus-Anschluss, gerade

Article number	Box / Big Box	Type
RADK2-R	10 pc. / 100 pc.	1/2"x3/4" EK

TILL EXHAUSTION OF STOCK

- 1
- 2
- 3
- 4
- 5
- 6
- 7
- 8
- 9
- 10
- 11



1
2
3
4
5
6
7
8
9
10
11

Type: RADTH-VL



Thermostatic radiator valve head
 Thermostatisch regelement met vaste vloeistofvoeler
 Tête thermostatique à bulbe, équipée d'un réglage de température limite
 Thermostatkopf mit festem Flüssigkeitsfühler

Article number	Box / Big Box	Type
RADTH-VL	10 pc. / 150 pc.	THERM

TILL EXHAUSTION OF STOCK

Type: RADV-2-R



2-way lockshield valve 1/2", straight x 3/4" eurocone
 Voetventiel 1/2" 2-weg recht x 3/4" euroconus
 Raccord droit réglable, 1/2" x eurocone
 Absperrbare Rücklaufverschraubung Durchgang x 3/4" Eurokonus

Article number	Box / Big Box	Type
RADV-2-R	10 pc. / 100 pc.	1/2"x3/4"

TILL EXHAUSTION OF STOCK

Type: RADH4-100H



Elbow radiator H-block with valve, supplied without nipple x 3/4" eurocone
 Radiator H-blok met afsluiter, haaks, geleverd zonder nippel x 3/4" euroconus
 Raccord robinet horizontal, eurocone, livré sans nipples
 Heizkörperanschlussgarnitur mit 3/4" Eurokonus-Anschlüssen, hinten

Article number	Box	Type
RADH4-100H	50 pc.	3/4"x3/4" EK

Type: RADNI



Nipple for H radiator block
 Nippel voor H-radiatorblok
 Vanne pour raccord radiateur (H&V)
 Nippel für H-Anschluss

Article number	Bag / Box	Type
RADNI-0504	10 pc. / 500 pc.	1/2"x3/4"



Type: RAD-H



Micromatic wheelhandle for thermostatic valve
Micromatisch handvat voor thermostatische kraan
Capuchon micromatique pour vanne thermostatique
Handgriff für Thermostatventil

Article number	Box	Type
RAD-H	50 pc.	HANDLE

TILL EXHAUSTION OF STOCK

Type: RAD-B



Elbow 1/2"
Koppeling 1/2"
Coude 1/2"
Winkel 1/2"

Article number	Box / Big Box	Type
RAD-B	25 pc. / 275 pc.	1/2"x3/4"

TILL EXHAUSTION OF STOCK

Type: BAP-H



Ball valve with handle, 2 x pressfitting
Kogelkraan met handvat, 2 x perskoppeling
Vanne à bille
Kugelhahnset mit Handgriff, 2 x Pressfitting

Article number	Box / Big Box	Type
BAP-H1616	8 pc. / 80 pc.	16x16
BAP-H1818	8 pc. / 80 pc.	18x18
BAP-H2020	8 pc. / 80 pc.	20x20
BAP-H2626	8 pc. / 80 pc.	26x26
BAP-H3232	5 pc. / 25 pc.	32x32



Type: BAP-SK



Ball valve with handle, 2 x pushfitting
 Kogelkraan met handvat, 2 x steekfitting
 Vanne à bille
 Kugelhahnset mit Handgriff, 2 x Pushfitting

Article number	Box / Big Box	Type
BAP-SK1616	6 pc. / 60 pc.	16x16
BAP-SK2020	6 pc. / 30 pc.	20x20
BAP-SK2626	6 pc. / 30 pc.	26x26

Type: BAP-SV



Stopvalve DN10
 Stopbolkraan DN10
 Vanne d'arrêt DN10
 Stopvalve DN10

Article number	Box / Big Box	Type
BAP-SV1610S	10 pc. / 100 pc.	16 x 10

Type: BAP-CH



Built in ball valve with crhomed lever handle 2 x pressfitting
 Inbouwbolkraan met verchromde hefboomhandvat, 2 x perskoppeling
 Vanne à sphere avec mache levier chromé, 2x raccord à sertir
 Einbau Kugelhahnset mit Hebelhandgriff verchromt, 2 x Pressfitting

Article number	Box / Big Box	Type
BAP-CH1616	5 pc. / 60 pc.	16x16
BAP-CH2626	5 pc. / 50 pc.	26x26



Type: BA-F



Built in ball valve Fastec DN15

Inbouwbolkraan Fastec DN15

Vanne à sphere Fastec DN15

Einbau Kugelhahnset Fastec DN15

Article number	Box / Big Box	Type
BA-F41	1 pc. / 50 pc.	

BA-F41



41S



41P



41SKS



- 1
- 2
- 3
- 4
- 5
- 6
- 7
- 8
- 9
- 10
- 11

UNDERFLOOR HEATING - VLOERVERWARMING - CHAUFFAGE PAR LE SOL - FUSSBODENHEIZUNG

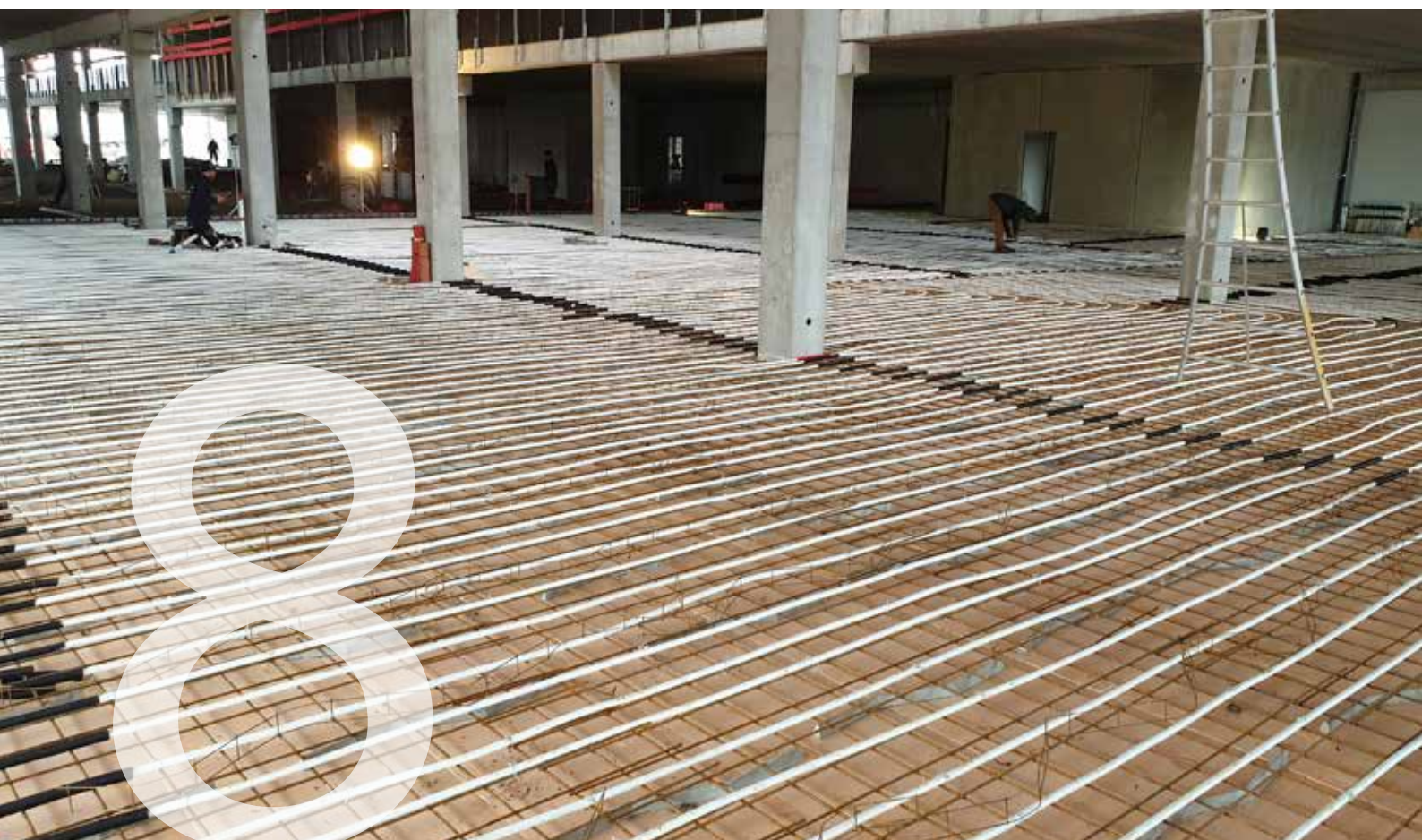

	<i>Page</i>
A. SYSTEMS	113
B. MANIFOLDS	125
C. CONTROL UNITS	136
D. GEOTHERMAL	146



Type: UFH-ISOPRO30



System plate with 30 mm EPS insulation and 28dB acoustic improvement
 Noppenplaat met 30 mm EPS isolatie, 28 dB geluidsverbetering
 Plaque à plot avec isolation EPS de 30 mm, isolant acoustique 28dB
 Systemplatte mit Dämmung Styropor 30 mm, Trittschallverbesserung 28dB

Article number	Packing	Type
UFH-ISOPRO30 *	6,72m ² (6 x 1,12m ²)	1400x800mm - 5kPa - 28dB

* Pipe Ø16, centre-to-centre: multiple 50mm hor./ver.

Type: UFH-ISOPRO11



System plate with 11 mm EPS insulation
 Noppenplaat met 11 mm EPS isolatie
 Plaque à plot avec isolation EPS de 11 mm
 Systemplatte mit Dämmung Styropor 11 mm

Article number	Packing	Type
UFH-ISOPRO11 *	14,56m ² (13 x 1,12m ²)	1400x800mm - 75kPa

* Pipe Ø16, centre-to-centre: multiple 50mm hor./ver.

Type: UFH-PRO



System plate without insulation
 Noppenplaat zonder isolatie
 Plaque à plot sans isolation
 Systemplatte ohne Dämmung

Article number	Packing	Type
UFH-PRO *	13,44m ² (12 x 1,12m ²)	1400x800mm - 5kPa

* Pipe Ø16, centre-to-centre: multiple 50mm hor./ver.

Type: UFH-PRO-DIA



Diagonal holder for system plate
 Diagonaalhouder voor noppenplaat
 Fixation diagonale en film PS
 Diagonalbefestigung aus PS

Article number	Packing	Type
UFH-PRO-DIA *	40 pc.	50 mm

* Centre-to-centre distance diagonal: multiple 70mm

Type: UFH-ISOPRO-AD30



Insulation plate for transition piece, 30 mm
 Isolatieplaat voor overgangsstuk, 30 mm
 Pièce de jonction en isolation EPS de 30 mm
 Anschlussstück aus Styropordämmung 30 mm

Article number	Packing	Type
UFH-ISOPRO-AD30	1 pc.	1000x200x30mm

TILL EXHAUSTION OF STOCK

Type: UFH-ISOPRO-AD11



Insulation plate for transition piece, 11 mm
 Isolatieplaat voor overgangsstuk, 11 mm
 Pièce de jonction en isolation EPS de 11 mm
 Anschlussstück aus Styropordämmung 11 mm

Article number	Packing	Type
UFH-ISOPRO-AD11	1 pc.	1000x200x11mm

TILL EXHAUSTION OF STOCK

Type: UFH-PRO-ADA



Transition piece without insulation for system plate
 Overgangsstuk zonder isolatie voor noppenplaat
 Pièce de jonction en film PS sans isolation
 Anschlussstück aus PS ohne Dämmung

Article number	Packing	Type
UFH-PRO-ADA	1 pc.	1450x210mm

Type: UFH-PRO-IND



System plate without insulation, industrial application
 Noppenplaat zonder isolatie, voor industriële toepassing
 Plaque à plot sans isolation, application industrielle
 Systemplatte ohne Dämmung, Industrieanwendungen

Article number	Packing	Type
UFH-PRO-IND *	19,44m ² (18 x 1,08m ²)	1275x975mm

* Pipe Ø16-20, centre-to-centre distance: multiple 75mm hor./ver.



Type: UFH-RAS10

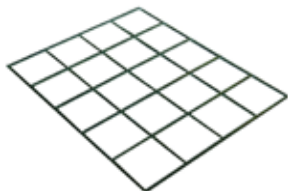

Galvanized steel mesh, 100 x 100 mm, 3 mm
 Stalen draadmat verzinkt, 100 x 100 mm, 3 mm
 Treillis en acier galvanisé, trame de 100 x 100 mm, 3 mm
 Trägermatte aus Eisen verzinkt, Masche 100 x 100 mm, 3 mm

Article number	Packing	Type
UFH-RAS10	10 pc.	2,52m ² - grid 100x100mm

Type: UFH-RAS15

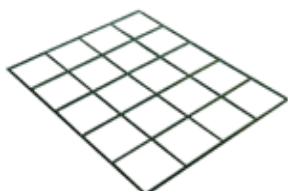

Galvanized steel mesh, 150 x 150 mm, 3 mm
 Stalen draadmat verzinkt, 150 x 150 mm, 3 mm
 Treillis en acier galvanisé, trame de 150 x 150 mm, 3 mm
 Trägermatte aus Eisen verzinkt, Masche 150 x 150 mm, 3 mm

Article number	Packing	Type
UFH-RAS15	10 pc.	2,52m ² - grid 150x150mm

Type: UFH-RAS20

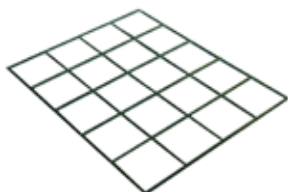

Galvanized steel mesh, 200 x 200 mm, 3 mm
 Stalen draadmat verzinkt, 200 x 200 mm, 3 mm
 Treillis en acier galvanisé, trame de 200 x 200 mm, 3 mm
 Trägermatte aus Eisen verzinkt, Masche 200 x 200 mm, 3 mm

Article number	Packing	Type
UFH-RAS20	10 pc.	2,88m ² - grid 200x200mm

Type: UFH-RAS25

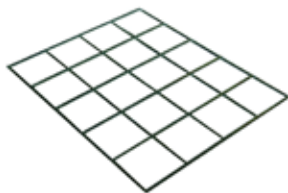

Galvanized steel mesh, 250 x 250 mm, 3 mm
 Stalen draadmat verzinkt, 250 x 250 mm, 3 mm
 Treillis en acier galvanisé, trame de 250 x 250 mm, 3 mm
 Trägermatte aus Eisen verzinkt, Masche 250 x 250 mm, 3 mm

Article number	Packing	Type
UFH-RAS25	10 pc.	2,77m ² - grid 250x250mm

- 1
- 2
- 3
- 4
- 5
- 6
- 7
- 8
- 9
- 10
- 11

Type: UFH-RAS-RB3



Connection clip for steel mesh
 Verbindingsclip voor stalen draadmatten
 Clip de fixation pour treillis
 Verbinder für Trägermatte

Article number	Packing	Type
UFH-RAS-RB3	30 pc.	RB

Type: UFH-RAS-BIND15



Steel strand, plasticized, to connect pipe on steel mesh
 Stalen vlechtdraad, geplastificeerd, om buis op draadmat te binden
 Fil de tressage métallique, plastifié, pour fixer tube sur treillis
 Stahldraht, plastifiziert, für Befestigung der Rohre auf Trägermatte

Article number	Packing	Type
UFH-RAS-BIND15A	250 pc.	160 mm
UFH-RAS-BIND15B	2500 pc.	160 mm

Type: UFH-RAS-CLIP



Synthetic clip for steel mesh
 Kunststofclip voor draadmat
 Attache en plastique pour treillis
 Rohrclip für Trägermatte

Article number	Packing	Type
UFH-RAS-CLIP16	200 pc.	Ø16
UFH-RAS-CLIP18	200 pc.	Ø18
UFH-RAS-CLIP20	200 pc.	Ø20

Type: UFH-TACK-KLS



Tacker sheet with EPS insulation, foil with 100 x 100 mm grid marking and overlap, acoustic improvement

Tacker klapset met EPS isolatie voorzien van folie met raster 100 x 100 mm en overlap, geluidsverbetering

Plaque tacker en isolation EPS, film avec trame 100 x 100 mm et rabat, isolant acoustique

Verbundplatte aus Styropordämmung mit Folie Masche 100 x 100 mm und Überschneidung, Trittschallverbesserung

Article number	Packing	Type
UFH-TACK-KLS15	10 m ² (5 x 2 m ²)	1000x2000x15mm - 4kPa - 17dB
UFH-TACK-KLS20	10 m ² (5 x 2 m ²)	1000x2000x20mm - 4kPa - 33dB
UFH-TACK-KLS25	10 m ² (5 x 2 m ²)	1000x2000x25mm - 4kPa - 33dB
UFH-TACK-KLS30	10 m ² (5 x 2 m ²)	1000x2000x30mm - 4kPa - 33dB



Type: UFH-TACK-ROL



Tacker roll with EPS insulation, foil with marking 100 x 100 mm and overlap, up to 29dB acoustic improvement

Tacker rol met EPS isolatie voorzien van folie met raster 100 x 100 mm en overlap, tot 29dB geluidsverbetering

Rouleau tacker en isolation EPS, film plastique avec trame 100 x 100 mm et rabat, isolant acoustique jusqu'à 29dB

Roll-Dämmung aus Styropor mit Folie 100 x 100 mm und Überschneidung, Trittschallverbesserung bis 29dB

Article number	Packing	Type
UFH-TACK-ROL20	10 m ² (1 x 10 m ²)	1000x10.000x20mm - 4kPa - 28dB
UFH-TACK-ROL25	10 m ² (1 x 10 m ²)	1000x10.000x25mm - 4kPa - 28dB
UFH-TACK-ROL30	10 m ² (1 x 10 m ²)	1000x10.000x30mm - 4kPa - 29dB
UFH-TACK-ROL35	10 m ² (1 x 10 m ²)	1000x10.000x35mm - 4kPa - 29dB

Type: UFH-TACK-38K



Tacker clip, 38 mm

Tackernagel, 38 mm

Agrafe tacker, 38 mm

Tackernadel, 38 mm

Article number	Box / Big Box	Type
UFH-TACK-38K *	300 pc. / 6000 pc.	38 mm

* Pipe Ø 16

Type: UFH-TACK-40



Tacker clip, 40 mm

Tackernagel, 40 mm

Agrafe tacker, 40 mm

Tackernadel, 40 mm

Article number	Box / Big Box	Type
UFH-TACK-40 *	300 pc. / 8.400 pc.	40 mm

* Pipe Ø 16-20

Type: UFH-TACK-60



Tacker clip, 60 mm

Tackernagel, 60 mm

Agrafe tacker, 60 mm

Tackernadel, 60 mm

Article number	Box / Big Box	Type
UFH-TACK-60 *	300 pc. / 6.000 pc.	60 mm

* Pipe Ø 16-20

A. SYSTEMS

Type: UFH-TACK



Tacker machine for UFH-TACK-40, UFH-TACK-60
 Tackerapparaat voor UFH-TACK-40, UFH-TACK-60
 Appareil Tacker pour UFH-TACK-40, UFH-TACK-60
 Tackergerät für UFH-TACK-40, UFH-TACK-60

Article number	Packing	Type
UFH-TACK	1 pc.	for UFH-TACK-40 / UFH-TACK-60

Type: UFH-SCOTCH-66



Adhesive tape
 Kleefband
 Ruban adhésif
 Klebeband

Article number	Packing	Type
UFH-SCOTCH-66	1 pc.	66 m

Type: UFH-P18-GP18



Gypsum fibreboard 18mm, round milling for RENO12 system
 Gipsvezelplaat 18mm, ronde frezing voor RENO12 systeem
 Plaques en fibro-plâtre 18mm, avec une fraisure circulaire système RENO12
 Gipsfaserplatte 18mm, runde Fräsung für das RENO12 system

Article number	pc	Type
UFH-P18-GP18	1 pc.	1000 x 600 x 18mm

Type: UFH-P18-GP18V



Gypsum fibreboard 18mm, vertical milling for RENO12 system
 Gipsvezelplaat 18mm, verticale frezing voor RENO12 systeem
 Plaques en fibro-plâtre 18mm, système RENO12
 Gipsfaserplatte 18mm, vertikale Fräsung für das RENO12 system

Article number	pc	Type
UFH-P18-GP18V	1 pc.	1000 x 600 x 18mm



Type: UFH-P18-GP10



Gypsum fibreboard 10mm, flat for RENO12 system
 Gipsvezelplaat 10mm, vlak voor RENO12 systeem
 Plaques en fibro-plâtre 10mm, système RENO12
 Gipsfaserplatte 10mm, flach für das RENO12 system

Article number	pc	Type
UFH-P18-GP10	1 pc.	1500 x 1000 x 10mm

Type: UFH-P18-WN



Mesh for RENO12 system
 Wapeningsnet voor RENO12 systeem
 Treillis d'armature système RENO12
 Betonstahlmatte für das RENO12 system

Article number	Packing	Type
UFH-P18-WN	50 m ²	1 x 50m

Type: UFH-ISODRY-25



Insulation system board for dry system
 Isolatieplaat voor droog systeem
 Panneau d'isolation pour système sec
 Systemplatte für Trockenbau

Article number	Packing	Type
UFH-ISODRY-25	10 m ²	1000x500x25mm

Type: UFH-DRY-GP100-2



Heat diffusion profile for dry system
 Stralingsprofiel voor droog systeem
 Profil de diffusion pour système sec
 Wärmeleitlamelle für Trockenbau

Article number	Packing	Type
UFH-DRY-GP100-2	50 pc.	997x120x0,4mm - Ø16

- 1
- 2
- 3
- 4
- 5
- 6
- 7
- 8
- 9
- 10
- 11

A. SYSTEMS

Type: UFH-DRY-VD100



Heat diffusion board for dry system
Stralingsverdeelplaat voor droog systeem
Panneau de diffusion pour système sec
Verteillerbleche für Trockenbau

Article number	Packing	Type
UFH-DRY-VD100	1 pc.	1000x1000mm

Type: UFH-DRY-B



Synthetic mounting bracket for pipe in diagonal position
kunststofbeugel voor bevestiging buis bij diagonaalverlegging
Fixation en plastique pour pose du tube diagonal
Kunststoffreiter für Diagonalverlegung

Article number	Packing	Type
UFH-DRY-B	100	

Type: UFH-UP-M



Clip rail with adhesive strip, centres 50 mm
U-profiel met kleefband, verlegafstand 50 mm
Profil-U avec bande adhésif, distance de pose 50 mm
Kunststoffclip-Schiene klebfertig für Rohr, Verlegung 50 mm

Article number	Box / Pallet	Type
UFH-UP-14M1	100 m / 1000 m	Ø14 - AS 25 mm- 1000 mm
UFH-UP-16M1	100 m / 1000 m	Ø16 - AS 50 mm- 1000 mm

Type: UFH-UP



Clip rail with adhesive strip, centres 50 mm
U-profiel met kleefband, verlegafstand 50 mm
Profil-U avec bande adhésif, distance de pose 50 mm
Kunststoffclip-Schiene klebfertig für Rohr, Verlegung 50 mm

Article number	Box / Pallet	Type
UFH-UP-12	32 m / 960 m	Ø12 - AS 25 mm- 2000 mm
UFH-UP-16	100 m / 3000 m	Ø16 - AS 50 mm- 2500 mm



Type: UFH-UP-CUP



Staple for clip rail
Clip voor U-profielen
Agrafe pour profil-U
Nadel für Schienen

Article number	Box / Big Box	Type
UFH-UP-CUP50	500 pc. / 9000 pc.	50 mm

Type: UFH-FOIL



PE film, transparant, with blue grid marking 50 x 50 mm
PE-folie, transparant, blauwe rastermarkering 50 x 50 mm
Film en PE, transparent avec marquage 50 x 50 mm en bleu
Polyethylen-Schutzfolie, transparent, Markierung Blau 50x50mm

Article number	Packing	Type
UFH-FOIL50	51 m ²	34m x 1,5m - 0,2mm
UFH-FOIL90	90 m ²	60m x 1,5m - 0,2mm

Type: UFH-FOIL-N



PE film, neutral
PE-folie, neutraal
Film en PE, neutre
Polyethylen-Schutzfolie, neutral

Article number	Packing	Type
UFH-FOIL-N	100 m ²	50 m x 2 m - 0,2 mm

Type: UFH-FOIL-ALU



PE film, reflecting ALU
PE-folie, met PE-flap en ALU reflectie
Film en PE avec réflexion ALU
Polyethylen-Schutzfolie, Reflition ALU

Article number	Packing	Type
UFH-FOIL-ALU	50 m ²	50 m x 1 m - 3,0 mm

Type: UFH-FOIL-CLIP25



Clip for Film
Dampffolienagel
Agrafe pour film PE
Foliendübel

Article number	Packing	Type
UFH-FOIL-CLIP25	100 pc.	25 mm

Type: UFH-PLUG80



Plug, shaft length 80 mm, Ø8 mm
Montageplug, schachtlengte 80 mm, Ø8 mm
Cheville de montage, longueur 80 mm, Ø8 mm
Niederhaltedübel, Bohrer Ø 8 mm, Schaftlänge 80 mm

Article number	Packing	Type
UFH-PLUG80	100 pc.	80 mm, Ø8 mm

Type: UFH-ISOBOARD-S



PE edge isolation with lapping strip and adhesive strip
Randisolatie uit PE-schuim met PE-flap en kleefstroken
Isolation périphérique en PE avec rabat et bande adhésif
Randdämmstreifen aus PE mit Abrisskante und Klebestreifen

Article number	Packing	Type
UFH-ISOBOARD-S	25 m	150 x 8 mm

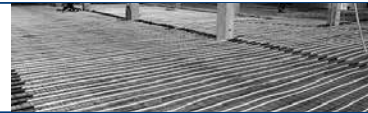

Type: UFH-ISOBOARD-GV



PE edge isolation with lapping strip and adhesive strip for liquid floors
 Randisolatie voor gietvloeren uit PE-schuim met flap en kleefstroken
 Isolation périphérique en PE avec rabat et bande adhésif, pour chape anhydrite
 Randdämmstreifen aus PE mit Abrisskante und Klebestreifen, für Fliessestrich

Article number	Packing	Type
UFH-ISOBOARD-GV	25 m	150 mm x 8 mm

Type: UFH-DP200



PE expansion joint with self-adhesive rail
 Uitzettingsvoeg uit PE-schuim met zelfklevende rail
 Joint de dilatation en PE avec bande adhésive
 Dehnungsfuge aus PE mit Klebestreifen

Article number	Packing	Type
UFH-DP200	2 m	2000 mm x 100 mm x 8 mm

Type: UFH-DH40



Protection sleeve for expansion joint
 Voegdoorganghuls
 Gaine de protection pour joint de dilatation
 Schutzrohre für Dehnungsfugen

Article number	Packing	Type
UFH-DH40	100 pc.	400 mm

Type: UFH-BEND



Bend guide for pipe
 Geleidingsbocht voor buis
 Courbe pour tube
 Rohrführungsbogen

Article number	Packing	Type
UFH-BEND1218	1 pc.	Ø 12 - 18 mm
UFH-BEND20	1 pc.	Ø 20 mm

- 1
- 2
- 3
- 4
- 5
- 6
- 7
- 8
- 9
- 10
- 11

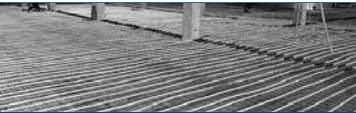

A. SYSTEMS

1 **Type: UFH-ADN10**



Additive for screed (min. pipe covering 45 mm)

Toevoegmiddel voor zandcementvloer (min. buisoverdking 45 mm)

Additif pour chape de ciment (min. épaisseur de chape au-dessus du tube 45 mm)

Estrichzusatz (min. Rohrüberdeckung 45 mm)

Article number	Packing	Type
UFH-ADN10	10 L	

B. MANIFOLDS



Type: UFH-06-MD



Manifold brass, adjustable, with flow meters
Verdeler messing, regelbaar, met debietmeting
Collecteur en laiton, réglable, avec débitmètres
Verteiler aus Messing, regelbar, mit Durchflussmengenmesser

Article number	Packing	Type
UFH-060502-MD	1 pc.	1"M - 2 x 3/4"
UFH-060503-MD	1 pc.	1"M - 3 x 3/4"
UFH-060504-MD	1 pc.	1"M - 4 x 3/4"
UFH-060505-MD	1 pc.	1"M - 5 x 3/4"
UFH-060506-MD	1 pc.	1"M - 6 x 3/4"
UFH-060507-MD	1 pc.	1"M - 7 x 3/4"
UFH-060508-MD	1 pc.	1"M - 8 x 3/4"
UFH-060509-MD	1 pc.	1"M - 9 x 3/4"
UFH-060510-MD	1 pc.	1"M - 10 x 3/4"
UFH-060511-MD	1 pc.	1"M - 11 x 3/4"
UFH-060512-MD	1 pc.	1"M - 12 x 3/4"

Type: UFH-M-D



Flow meter for brass manifold
Debietmeter voor messing verdeler
Débitmètre pour collecteur en laiton
Durchflussmengenanzeiger für Verteiler aus Messing

Article number	Packing	Type
UFH-M-D	1 pc.	

Type: UFH-PGKTA



Pump unit A label pump with consistent temperature control
Pompgroep A-label met regeling voor constante temperatuur
Kit pompe label A avec régulation de température constante
Konstanttemperaturregelung mit A-Pumpe

Article number	Packing	Type
UFH-PGKTA	1 pc.	1"F / 27°C - 42°C

B. MANIFOLDS

Type: UFH-PGKTA-TH



Thermostatic sensor UFH-PGKTA
 Thermostaat kop voor UFH-PGKTA
 Tête thermostatique UFH-PGKTA
 Thermostatkopf UFH-PGKTA

Article number	Packing	Type
UFH-PGKTA-TH	1 pc.	

Type: UFH-GKT



Unit with consistent temperature control without pump
 Groep met regeling voor constante temperatuur zonder pomp
 Kit avec régulation de température constante sans pompe
 Konstanttemperaturregelung ohne Pump

Article number	Packing	Type
UFH-GKT	1 pc.	1" F / 27°C - 42°C

Type: UFH-BT-M



1" F ball valve with 1" F swivel nut, washer and thermometer
 Kogelkraan 1" F met wartelmoer 1" F , dichting en thermometer
 Vanne à sphère 1" F avec écrou 1" F, joint et thermomètre
 Kugelhahnset 1" IG mit Mutter 1" IG , Dichtung und Thermometer

Article number	Packing	Type
UFH-BTM0606-M	1 set (2 pc.)	1" F x 1" F / 0 - 60 °

Type: UFH-B-M



1" F ball valve with 1" F swivel nut and washer
 Kogelkraan 1" F met wartelmoer 1" F en dichting
 Vanne à sphère 1" F avec écrou 1" F et joint plat
 Kugelhahnset 1" IG mit Mutter 1" IG und Dichtung

Article number	Packing	Type
UFH-B0606-M	1 set (2 pc.)	1" F x 1" F

B. MANIFOLDS



Type: UFH-ESK-M



1" F end cap with nut, washer, ball valve and air vent 3/8"
 Eindstuk 1" F met moer, dichting, kogelkraan en ontluftingskraan 3/8"
 Bouchon terminal 1" F avec écrou, vanne à sphère, joint et purgeur 3/8"
 Verteilerendstückset 1" IG mit Mutter und Dichtung, Enlüftung 3/8", Kugelhahnset, Entleerung 1/2"

Article number	Packing	Type
UFH-ESK060303-M	1 set (2 pc.)	1" F x 1/2" x 3/8"

Type: UFH-AO-MZ



Automatic air vent, without check valve
 Automatische ontlufter, zonder waterslot
 Purgeur automatique, sans serrure d'eau
 Schnellentlüfter mit vertikaler Entlüftung, ohne Wasserabspernung

Article number	Packing	Type
UFH-AO03-MZ	1 pc.	3/8"

Type: UFH-TM-M



Thermometer for return with EK connections
 Thermometer voor terugvoer met euroconus aansluitingen
 Retour thermomètre avec raccordement eurocone
 Thermometer zum Anschluss Rücklauf mit Eurokonus-Anschlüssen

Article number	Packing	Type
UFH-TM050-M	1 pc.	3/4" - 3/4" EK / 0

Type: UFH-BS-M



End cap with washer
 Blindstop
 Bouchon
 Kappe mit Dichtung

Article number	Packing	Type
UFH-BS05-M	1 pc.	3/4"

B. MANIFOLDS

Type: UFH-MDSS



Stainless steel manifold
Roestvrij stalen verdeler
Distributeur en acier inoxydable
Edelstahlverteiler

Article number	Packing	Type
UFH-0605MDSS02	1 pc.	1" - 2 x 3/4"
UFH-0605MDSS03	1 pc.	1" - 3 x 3/4"
UFH-0605MDSS04	1 pc.	1" - 4 x 3/4"
UFH-0605MDSS05	1 pc.	1" - 5 x 3/4"
UFH-0605MDSS06	1 pc.	1" - 6 x 3/4"
UFH-0605MDSS07	1 pc.	1" - 7 x 3/4"
UFH-0605MDSS08	1 pc.	1" - 8 x 3/4"
UFH-0605MDSS09	1 pc.	1" - 9 x 3/4"
UFH-0605MDSS10	1 pc.	1" - 10 x 3/4"
UFH-0605MDSS11	1 pc.	1" - 11 x 3/4"
UFH-0605MDSS12	1 pc.	1" - 12 x 3/4"
UFH-0605MDSS13	1 pc.	1" - 13 x 3/4"
UFH-0605MDSS14	1 pc.	1" - 14 x 3/4"
UFH-0605MDSS15	1 pc.	1" - 15 x 3/4"

Type: UFH-BT-VN



1" F ball valve with 1" F swivel nut, washer and thermometer, nickel-plated
Kogelkraan 1" F met wartelmoer 1" F, dichting en thermometer, vernikkeld
Vanne à sphère 1" F avec écrou 1" F, joint et thermomètre, nickelé
Kugelhahnset 1" IG mit Mutter 1" IG, Dichtung und Thermometer, vernickelt

Article number	Packing	Type
UFH-BTM0606-VN	1 set (2 pc.)	1" F x 1" F

Type: UFH-B-VN



1" F ball valve with 1" F swivel nut and washer, nickel-plated
Kogelkraan 1" F met wartelmoer 1" F en dichting, vernikkeld
Vanne à sphère 1" F avec écrou 1" F et joint, nickelé
Kugelhahnset 1" IG mit Mutter 1" IG und Dichtung, vernickelt

Article number	Packing	Type
UFH-B0606-VN	1 set (2 pc.)	1" F x 1" F / 0 - 60 °

Type: UFH-ESK-VN



1" F end cap with nut, washer, ball valve and air vent 3/8", nickel-plated
Eindstuk 1" F met moer, dichting, kogelkraan en ontluftingskraan 3/8", vernikkeld
Bouchon terminal 1" F avec écrou, joint et purgeur 3/8", nickelé
Verteilerendstückset 1" IG mit Mutter und Dichtung, Entlüftung 3/8", Kugelhahnset, vernickelt

Article number	Packing	Type
UFH-ESK060303-VN	1 set (2 pc.)	1" F x 1/2" x 3/8"

B. MANIFOLDS



Type: UFH-MDK



Manifold composite, adjustable with flow meter, thermometer washer and air vent
Composiet verdeler, regelbaar met debietmeting, thermometer, vul- en aftapkraan, ontluchter

Collecteur composite, réglable avec débitmètre, thermomètre, purge et purgeur d'air

Verteiler Composite, regelbar mit Durchflussmengenmesser, Thermomesser, Entleerung und Entlüfter

Article number	Packing	Type
UFH-0605MDK02	1 pc.	1" - 2 x 3/4"
UFH-0605MDK03	1 pc.	1" - 3 x 3/4"
UFH-0605MDK04	1 pc.	1" - 4 x 3/4"
UFH-0605MDK05	1 pc.	1" - 5 x 3/4"
UFH-0605MDK06	1 pc.	1" - 6 x 3/4"
UFH-0605MDK07	1 pc.	1" - 7 x 3/4"
UFH-0605MDK08	1 pc.	1" - 8 x 3/4"
UFH-0605MDK09	1 pc.	1" - 9 x 3/4"
UFH-0605MDK10	1 pc.	1" - 10 x 3/4"
UFH-0605MDK11	1 pc.	1" - 11 x 3/4"
UFH-0605MDK12	1 pc.	1" - 12 x 3/4"

Type: UFH-MDK-CON



Composite connector for MDK manifold

Composiet verbinder voor MDK verdeler

Connecteur en composite pour collecteur MDK

Composiet Verbinder für MDK Verteiler

Article number	Bag / Box	Type
UFH-MDK-CON	1 pc. / 50 pc.	

Type: UFH-BM-VN



Ball valve with gasket, nickel-plated

Kogelkraan met dichting, vernikkeld

Vanne à sphère et joint, nickelé

Kugelhahnset, vernickelt

Article number	Packing	Type
UFH-B0605-VN	1 set (2 pc.)	3/4" x 1"
UFH-BM0606-VN	1 set (2 pc.)	1" x 1"

B. MANIFOLDS

Type: UFH-CDP



Manifold composite, adjustable with flow meter and A-pump
Composiet verdeler, regelbaar met debietmeting en A-pomp
Collecteur composite, réglable avec débitmètre et pompe label A
Verteiler Composite, regelbar mit Durchflussmengenmesser und A-Pumpe

Article number	Packing	Type
UFH-0405CDP01	1 pc.	1/2" - 1 x 3/4"
UFH-0405CDP02	1 pc.	1/2" - 2 x 3/4"
UFH-0405CDP03	1 pc.	1/2" - 3 x 3/4"
UFH-0405CDP04	1 pc.	1/2" - 4 x 3/4"
UFH-0405CDP05	1 pc.	1/2" - 5 x 3/4"
UFH-0405CDP06	1 pc.	1/2" - 6 x 3/4"
UFH-0505CDP07	1 pc.	3/4" - 7 x 3/4"
UFH-0505CDP08	1 pc.	3/4" - 8 x 3/4"
UFH-0505CDP09	1 pc.	3/4" - 9 x 3/4"
UFH-0505CDP10	1 pc.	3/4" - 10 x 3/4"
UFH-0505CDP11	1 pc.	3/4" - 11 x 3/4"
UFH-0505CDP12	1 pc.	3/4" - 12 x 3/4"
UFH-0505CDP13	1 pc.	3/4" - 13 x 3/4"
UFH-0505CDP14	1 pc.	3/4" - 14 x 3/4"
UFH-0505CDP15	1 pc.	3/4" - 15 x 3/4"
UFH-0505CDP16	1 pc.	3/4" - 16 x 3/4"

Also available with Active Flow Control

Type: UFH-CD

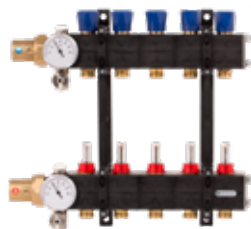

Manifold composite, adjustable with flow meter
Composiet verdeler, regelbaar met debietmeting
Collecteur composite, réglable avec débitmètre
Verteiler Composite, regelbar mit Durchflussmengenmesser

Article number	Packing	Type
UFH-0605CD01	1 pc.	1" - 1 x 3/4"
UFH-0605CD02	1 pc.	1" - 2 x 3/4"
UFH-0605CD03	1 pc.	1" - 3 x 3/4"
UFH-0605CD04	1 pc.	1" - 4 x 3/4"
UFH-0605CD05	1 pc.	1" - 5 x 3/4"
UFH-0605CD06	1 pc.	1" - 6 x 3/4"
UFH-0605CD07	1 pc.	1" - 7 x 3/4"
UFH-0605CD08	1 pc.	1" - 8 x 3/4"
UFH-0605CD09	1 pc.	1" - 9 x 3/4"
UFH-0605CD10	1 pc.	1" - 10 x 3/4"
UFH-0605CD11	1 pc.	1" - 11 x 3/4"
UFH-0605CD12	1 pc.	1" - 12 x 3/4"
UFH-0605CD13	1 pc.	1" - 13 x 3/4"
UFH-0605CD14	1 pc.	1" - 14 x 3/4"
UFH-0605CD15	1 pc.	1" - 15 x 3/4"
UFH-0605CD16	1 pc.	1" - 16 x 3/4"
UFH-0605CD17	1 pc.	1" - 17 x 3/4"
UFH-0605CD18	1 pc.	1" - 18 x 3/4"
UFH-0605CD19	1 pc.	1" - 19 x 3/4"
UFH-0605CD20	1 pc.	1" - 20 x 3/4"

Also available with Active Flow Control

B. MANIFOLDS

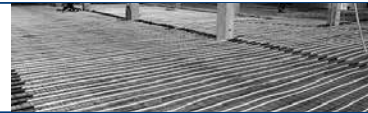

Type: UFH-CAF



Manifold composite, adjustable with active flow control
 Composiet verdeler, regelbaar met active flow control
 Collecteur composite, réglable avec active flow control
 Verteiler Composite, regelbar mit active flow control

Article number	Packing	Type
UFH-0605CAF01	1 pc.	1" - 1 x 3/4"
UFH-0605CAF04	1 pc.	1" - 4 x 3/4"

TILL EXHAUSTION OF STOCK

Type: UFH-CDWE



Manifold composite project che with heat exchanger and dirt separator
 Composiet verdeler project cwe met warmtewisselaar en vuilafscheider
 Collecteur composite projet cev avec échangeur de chaleur et séparateur de boue
 Verteiler Composite projt cwa mit Wärmetauscher und Schlammabscheider

Article number	Packing	Type
UFH-0505CDWE01	1 pc.	3/4" - 1 x 3/4"
UFH-0505CDWE06	1 pc.	3/4" - 6 x 3/4"
UFH-0505CDWE08	1 pc.	3/4" - 8 x 3/4"
UFH-0505CDWE09	1 pc.	3/4" - 9 x 3/4"

TILL EXHAUSTION OF STOCK

Type: UFH-CP



A-pump unit for composite collector
 Pompunit composiet verdeler, met A-pomp
 Kit pompe-A pour collecteur composite
 A-Pump Unit für Composite Verteiler

Article number	Packing	Type
UFH-CP	1 pc.	

B. MANIFOLDS

Type: UFH-SECO



Steel collector with A-pump
Stalen verdeler met A-pomp
Collecteur en acier avec pompe label A
Verteiler Stahl mit A-Pump

Article number	Packing	Type
UFH-0405SECO01	1 pc.	1/2" - 1 x 3/4"
UFH-0405SECO02	1 pc.	1/2" - 2 x 3/4"
UFH-0405SECO03	1 pc.	1/2" - 3 x 3/4"
UFH-0405SECO04	1 pc.	1/2" - 4 x 3/4"
UFH-0405SECO05	1 pc.	1/2" - 5 x 3/4"
UFH-0405SECO06	1 pc.	1/2" - 6 x 3/4"
UFH-0505SECO07	1 pc.	3/4" - 7 x 3/4"
UFH-0505SECO08	1 pc.	3/4" - 8 x 3/4"
UFH-0505SECO09	1 pc.	3/4" - 9 x 3/4"
UFH-0505SECO10	1 pc.	3/4" - 10 x 3/4"
UFH-0505SECO11	1 pc.	3/4" - 11 x 3/4"
UFH-0505SECO12	1 pc.	3/4" - 12 x 3/4"
UFH-0505SECO13	1 pc.	3/4" - 13 x 3/4"
UFH-0505SECO14	1 pc.	3/4" - 14 x 3/4"
UFH-0505SECO15	1 pc.	3/4" - 15 x 3/4"
UFH-0505SECO16	1 pc.	3/4" - 16 x 3/4"

Type: UFH-SSTN



Steel collector with pump, district heating nuon and eneco
Stalen verdeler met pomp, stadsverwarming nuon en eneco
Collecteur en acier avec pompe, chauffage urbain nuon et eneco
Verteiler Stahl mit Pump, Fernheizung nuon und eneco

Article number	Packing	Type
UFH-0405SSTN01	1 pc.	1/2" - 1 x 3/4"
UFH-0405SSTN02	1 pc.	1/2" - 2 x 3/4"
UFH-0405SSTN03	1 pc.	1/2" - 3 x 3/4"
UFH-0405SSTN04	1 pc.	1/2" - 4 x 3/4"
UFH-0405SSTN05	1 pc.	1/2" - 5 x 3/4"
UFH-0405SSTN06	1 pc.	1/2" - 6 x 3/4"
UFH-0505SSTN07	1 pc.	3/4" - 7 x 3/4"
UFH-0505SSTN08	1 pc.	3/4" - 8 x 3/4"
UFH-0505SSTN09	1 pc.	3/4" - 9 x 3/4"
UFH-0505SSTN10	1 pc.	3/4" - 10 x 3/4"
UFH-0505SSTN11	1 pc.	3/4" - 11 x 3/4"
UFH-0505SSTN12	1 pc.	3/4" - 12 x 3/4"

B. MANIFOLDS



Type: UFH-SSTE



Steel collector with pump, district heating essent
 Stalen verdeler met pomp, stadsverwarming essent
 Collecteur en acier avec pompe, chauffage urbain essent
 Verteiler Stahl mit Pump, Fernheizung essent

Article number	Packing	Type
UFH-0405SSTE01	1 pc.	1/2" - 1 x 3/4"
UFH-0405SSTE02	1 pc.	1/2" - 2 x 3/4"
UFH-0405SSTE03	1 pc.	1/2" - 3 x 3/4"
UFH-0405SSTE04	1 pc.	1/2" - 4 x 3/4"
UFH-0405SSTE05	1 pc.	1/2" - 5 x 3/4"
UFH-0405SSTE06	1 pc.	1/2" - 6 x 3/4"
UFH-0505SSTE07	1 pc.	3/4" - 7 x 3/4"
UFH-0505SSTE08	1 pc.	3/4" - 8 x 3/4"
UFH-0505SSTE09	1 pc.	3/4" - 9 x 3/4"
UFH-0505SSTE10	1 pc.	3/4" - 10 x 3/4"
UFH-0505SSTE11	1 pc.	3/4" - 11 x 3/4"
UFH-0505SSTE12	1 pc.	3/4" - 12 x 3/4"

Type: UFH-LTV

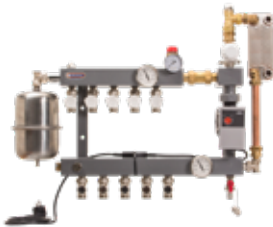

Steel collector with A-pump and plate heat exchanger (low temperature)
 Stalen verdeler met A-pomp en scheidingswisselaar voor LT toepassing
 Collecteur en acier avec pompe label A et échangeur à plaques (temperature basse)
 Verteiler Stahl mit A-Pump und Plattenwärmetauscher (niedrigen Temperaturen)

Article number	Packing	Type
UFH-0405LTV01	1 pc.	1/2" - 1 x 3/4"
UFH-0405LTV02	1 pc.	1/2" - 2 x 3/4"
UFH-0405LTV03	1 pc.	1/2" - 3 x 3/4"
UFH-0405LTV04	1 pc.	1/2" - 4 x 3/4"
UFH-0405LTV05	1 pc.	1/2" - 5 x 3/4"
UFH-0405LTV06	1 pc.	1/2" - 6 x 3/4"
UFH-0505LTV07	1 pc.	3/4" - 7 x 3/4"
UFH-0505LTV08	1 pc.	3/4" - 8 x 3/4"
UFH-0505LTV09	1 pc.	3/4" - 9 x 3/4"
UFH-0505LTV10	1 pc.	3/4" - 10 x 3/4"
UFH-0505LTV11	1 pc.	3/4" - 11 x 3/4"
UFH-0505LTV12	1 pc.	3/4" - 12 x 3/4"

B. MANIFOLDS

Type: UFH-MAXB55



Maximum temperature safety cut-out switch
 Maximaalbeveiligingsschakelaar
 Interrupteur de protection maximal
 Maximalschutzschalter

Article number	Packing	Type
UFH-MAXB55	1 pc.	Max. 55 °C

TILL EXHAUSTION OF STOCK

Type: UFH-MAX95



Maximum temperature safety cut-out switch 50 -95°C
 Maximaalthermostaat, 50 - 95°C
 Thermostat de sécurité, 50 - 95 °C
 Maximalschutzschalter, 50 - 95 °C

Article number	Packing	Type
UFH-MAX95	1 pc.	50 - 95°C - 15A / 230V

TILL EXHAUSTION OF STOCK

Type: UFH-C191645



Thermostatic sensor 10/60°C with short probe
 Thermostaat voeler 10/60°C met korte sensor
 Tête thermostatique 10/60°C avec senseur court
 Thermostat 10/60°C mit kurze Fühler

Article number	Packing	Type
UFH-C191645		

Type: UFH-C191974 - 76



Circulator Wilo Yonos Para RS 15/6-RKA KU 130mm (excl. wire/plug)
 Circulator Wilo Yonos Para RS 15/6-RKA KU 130mm (excl. snoer/stekker)
 Circulateur Wilo Yonos Para RS 15/6-RKA KU 130mm (excl. fil/prise)
 Cirkulator Wilo Yonos Para RS 15/6-RKA KU 130mm (excl. Snur/Stecker)

Article number	Packing	Type
UFH-C191974		1"
UFH-C191976		1 1/2"

B. MANIFOLDS



Type: UFH-C192071



Safety thermostat incl. wire/plug
Maximaal thermostaat incl. snoer/stekker
Thermostat de sécurité incl. fil/prise
Maximal Thermostat incl. Snur/Stecker

Article number	Packing	Type
UFH-C192071	1 pc.	

Type: UFH-C191800



Thermometer with immersion sleeve 0/60 gr.
Thermometer met dompelbuis temp 0/60 gr.
Thermomètre temp. 0/60 gr. avec bulbe
Thermometer mit Tauchhülse 0/60 gr.

Article number	Packing	Type
UFH-C191800	1 pc.	

1

2

3

4

5

6

7

8

9

10

11

C. CONTROL UNITS

1 **WIRED CONTROL UNIT**

2 **BEKABELDE ZONEREGELING**

3 **RÉGULATEURS DE ZONE CÂBLÉS**

4 **REGELVERTEILER VERDRAHTET**

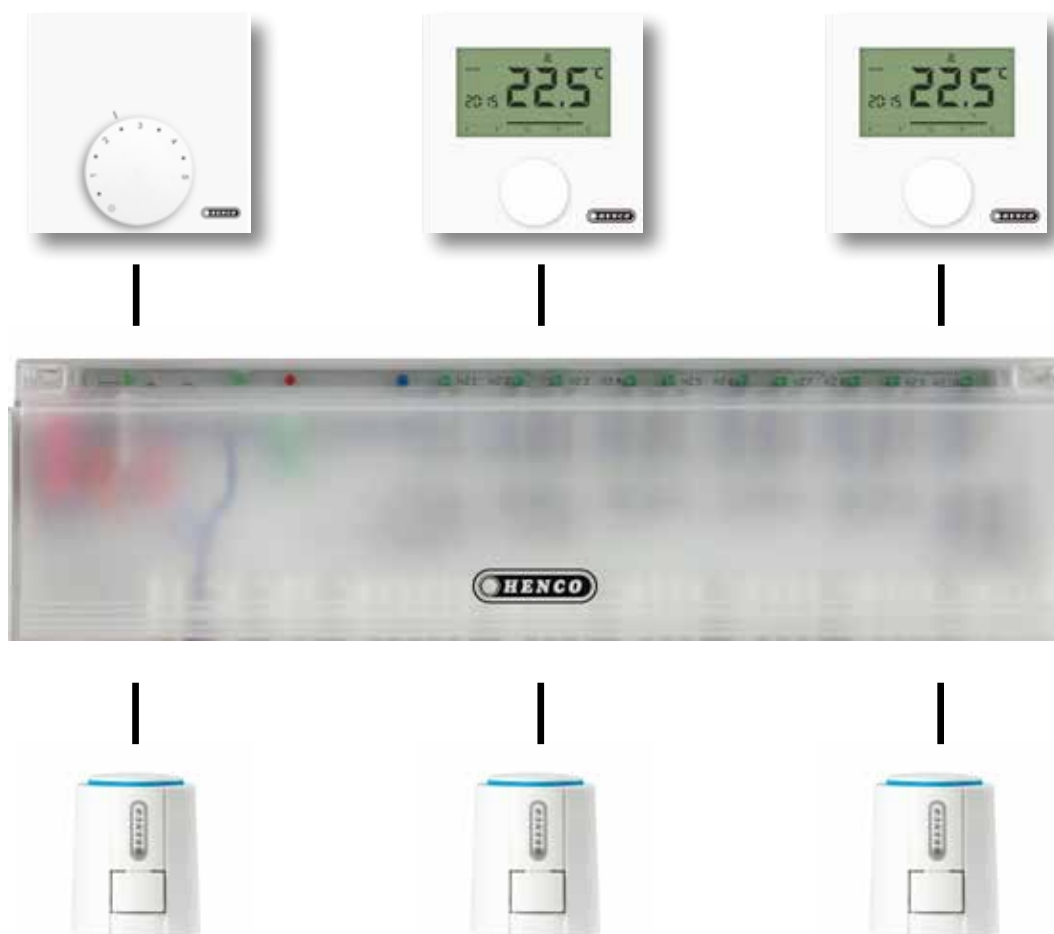



Type: CU-6ZONE



Base module 6 zones, transformator incl.

Basisstation 6 zonen, transformator incl.

Base module 6 zones, transformator incl.

Regelklemmleiste 6-Zonen, Basic, inkl. Transformator

Article number	Packing	Type
CU-6ZONE-24V	1 pc.	24V
CU-6ZONE-230V	1 pc.	230V

Type: CU-DINRAIL



Din rail

Din rail

Din rail

Befestigungsschiene für Regelklemmleiste

Article number	Packing	Type
CU-DINRAIL	1 pc.	

Type: CU-6ZONEP



Base module Plus 6 zones, transformator incl. (heating/cooling with pump contact)

Basisstation Plus 6 zonen, transformator incl. (verwarmen/koelen met pompsturing)

Base module Plus 6 zones, transformator incl. (chauffer/refroidir avec contact circulateur)

Regelklemmleiste Plus 6-Zonen, Basic, inkl. Transformator. (Heizung/Kühlung mit Pumpensteuerung)

Article number	Packing	Type
CU-6ZONEP-24V	1 pc.	24V
CU-6ZONEP-230V	1 pc.	230V

C. CONTROL UNITS

Type: CU-DINRAIL



Din rail
Din rail
Din rail
Befestigungsschiene für Regelklemmleiste

Article number	Packing	Type
CU-DINRAIL	1 pc.	

Type: CU-6ZONEK



Base module Comfort 6 zones, transformator (heating/cooling with pump contact and boiler contact)
Basismodule Comfort 6 zones, met transformator incl. (verwarmen/koelen met pompsturing en ketelsturing)
Module de base Comfort 6 zones, transformateur incl. (chauffer/refroidir avec contact circulateur et contact boiler)
Regelklemmleiste 6-Zonen, Komfort, inkl. Transformator (Heizung/Kühlung mit Pumpensteuerung und Boilersteuerung)

Article number	Packing	Type
CU-6ZONEK-24V	1 pc.	24V
CU-6ZONEK-230V	1 pc.	230V

Type: CU-10ZONEK



Base module Comfort 10 zones, transformator (heating/cooling with pump contact and boiler contact)
Basismodule Comfort 10 zones, met transformator incl. (verwarmen/koelen met pompsturing en ketelsturing)
Module de base Comfort 10 zones, transformateur incl. (chauffer/refroidir avec contact circulateur et contact boiler)
Regelklemmleiste 10-Zonen, Komfort, inkl. Transformator (Heizung/Kühlung mit Pumpensteuerung und Boilersteuerung)

Article number	Packing	Type
CU-10ZONEK-24V	1 pc.	24V
CU-10ZONEK-230V	1 pc.	230V



Type: CU-DINRAIL



Din rail

Din rail

Din rail

Befestigungsschiene für Regelklemmleiste

Article number	Packing	Type
CU-DINRAIL	1 pc.	

Type: CU-REGB



Analog thermostat

Regelaar analoog

Thermostat analogue

Raumthermostat, analog

Article number	Packing	Type
CU-REGB-24V	1 pc.	24V
CU-REGB-230V	1 pc.	230V

Type: CU-REGB-HC



Analog thermostat, heating/cooling

Regelaar analoog, verwarmen/koelen

Thermostat analogue, chauffer et refroidir

Raumthermostat, analog, heizen und kühlen

Article number	Packing	Type
CU-REGB-HC24V	1 pc.	24V
CU-REGB-HC230V	1 pc.	230V

C. CONTROL UNITS

Type: CU-REGK



LCD komfort thermostat 24V, heating/cooling
 Regelaar LCD comfort, 24V, verwarmen/koelen
 LCD confort thermostat 24V, chauffer et refroidir
 Raumthermostat, LCD 24V, heizen und kühlen

Article number	Packing	Type
CU-REGK-24V	1 pc.	24V
CU-REGK-230V	1 pc.	230V

Type: CU-REGC



LCD control thermostat 230V, heating/cooling + clock program
 Regelaar LCD control, 230V, verwarmen/koelen + klokfunctie
 LCD control thermostat 230v, chauffer et refroidir + programmation
 Raumthermostat, LCD, Control, 230V, heizen und kühlen + Zeitsangabe

Article number	Packing	Type
CU-REGC-24V	1 pc.	24V
CU-REGC-230V	1 pc.	230V

Type: CU-ACT



Act with cable 1m
 Act met vaste kabel 1m
 Act avec cable 1m
 Stellantrieb Kabel 1m

Article number	Packing	Type
CU-ACT-24V	1 pc.	24V
CU-ACT-230V	1 pc.	230V

Type: CU-ACT-PLUG



Act for plugcable
 Act voor steekbare kabel
 Act pour plugcable
 Sellantrieb für Stecker

Article number	Packing	Type
CU-ACT-24V-PLUG	1 pc.	24V
CU-ACT-230V-PLUG	1 pc.	230V



Type: CU-PLUGCABLE



Act plugcable
Losse kabel voor act
Act plugcable
Stecker Leitung

Article number	Packing	Type
CU-PLUGCABLE-2M	1 pc.	2 m
CU-PLUGCABLE-5M	1 pc.	5 m
CU-PLUGCABLE-15M	1 pc.	15 m

1

2

3

4

5

6

7

8

9

10

11

C. CONTROL UNITS

1 WIRELESS CONTROL UNIT (HEATING / COOLING)

2 DRAADLOZE ZONEREGELING (VERWARMEN / KOELEN)

3 RÉGULATEURS DE ZONE SANS FIL (CHAUFFAGE / REFRROIDISSEMENT)

4 REGELVERTEILER FUNK (HEIZEN / KÜHLEN)



C. CONTROL UNITS



Type: CU-MONO-RF



One zone module 230V
 Module 1 zone 230V
 Module zone individuelle 230V
 Regelklemmleiste 1-Zone, 230V

Article number	Packing	Type
CU-MONO-RF	1 pc.	

Type: CU-8ZONE-RF



Base module 8 zones, 230V LAN DIN rail incl. (heating/cooling)
 Basismodule 8 zones, 230V met LAN en DIN rail (verwarmen/koelen)
 Module de base 8 zones, 230V LAN + DIN rail incl. (chauffer/refroidir)
 Regelklemmleiste 8-Zonen, Funk 230V inkl. Befestigungsschiene (heizen und kühlen)

Article number	Packing	Type
CU-8ZONE-RF	1 pc.	

Type: CU-8ZONEB-RF



Base module 8 zones, 230V DIN rail incl. (heating/cooling)
 Basismodule 8 zones, 230V inclusief DIN rail (verwarmen/koelen)
 Module de base 8 zones, 230V DIN rail incl. (chauffer/refroidir)
 Regelklemmleiste 8-Zonen, inkl. Befestigungsschiene (heizen und kühlen)

Article number	Packing	Type
CU-8ZONEB-RF	1 pc.	

Type: CU-12ZONE-RF



Base module 12 zones, 230V LAN din rail incl. (heating/cooling)
 Basismodule 12 zones, 230V met LAN en DIN rail (verwarmen/koelen)
 Module de base 12 zones, 230V LAN + DIN rail incl. (chauffer/refroidir)
 Regelklemmleiste 12-Zonen, Funk 230V inkl. Befestigungsschiene (heizen und kühlen)

Article number	Packing	Type
CU-12ZONE-RF	1 pc.	

Type: CU-REGB-RF



Analog thermostat, 0-5 incl. batt (heating/cooling)
 Regelaar analog, met instelling 0-5 incl. batt. (verwarmen/koelen)
 Thermostat analogue, 0-5 incl. batt (chauffer/refroidir)
 Raumthermostat analog Funk inkl. Batterie (heizen und kühlen)

Article number	Packing	Type
CU-REGB-RF	1 pc.	

C. CONTROL UNITS

Type: CU-REGC-RF



Thermostat LCD, optional ext. sensor
 Regelaar LCD, met aansl. voor ext. sensor
 Thermostat LCD, option ext. sens
 Raumthermostat LCD Funk, optional mit externem Sensor

Article number	Packing	Type
CU-REGC-RF	1 pc.	

Type: CU-REGS-RF



Tamper free sensor
 Ruimte sensor zonder instelling
 Sonde sans bouton
 Raumthermostat 24V, Behördenmodell

Article number	Packing	Type
CU-REGS-RF	1 pc.	

Type: CU-REPEAT



Repeater
 Repeater
 Repeater
 Repeater

Article number	Packing	Type
CU-REPEAT	1 pc.	

Type: CU-ANT



Antenne
 Antenne
 Antenne
 Antenne

Article number	Packing	Type
CU-ANT	1 pc.	

Type: CU-SENS



External sensor
 Externe sensor
 Sonde externe
 Externer Sensor

Article number	Packing	Type
CU-SENS	1 pc.	3 m

C. CONTROL UNITS



Type: CU-ACT-230V-PLUG



Act for plugcable, 230V
Act voor steekbare kabel, 230V
Act pour plugcable, 230V
Stellantrieb für Stecker, 230V

Article number	Packing	Type
CU-ACT-230V-PLUG	1 pc.	

Type: CU-PLUGCABLE



Act plugcable
Losse kabel voor act
Act plugcable
Stecker Leitung

Article number	Packing	Type
CU-PLUGCABLE-2M	1 pc.	2 m
CU-PLUGCABLE-5M	1 pc.	5 m
CU-PLUGCABLE-15M	1 pc.	15 m

Type: UFH-H5004



Copper shroud for UFH-SENSOR
Koperen huls voor UFH-SENSOR
Doigt de gant pour UFH-SENSOR
Kupferhülse für UFH-SENSOR

Article number	Packing	Type
UFH-H5004	1 pc.	50 mm x 1/2"

Type: UFH-ANC



Valve
Zoneventiel
Vanne
Ventil

Article number	Packing	Type
UFH-ANC-05	1 pc.	2 x 3/4" - M30x1,5 - Kv 2
UFH-ANC-06	1 pc.	2 x 1" - M30x1,5 - Kv 4,5

Type: UFH-CDGEO



Manifold composite GEO, adjustable with flowmeter
Composiet verdeler GEO, regelbaar met debietmeting
Collecteur composite GEO, réglable avec débitmètre
Verteiler Composite GEO, regelbar mit Durchflussmengenmesser

Article number	Packing	Type
UFH-0626CD01	1 pc.	1" - 1 x Ø26
UFH-0626CD03	1 pc.	1" - 3 x Ø26
UFH-0626CD04	1 pc.	1" - 4 x Ø26
UFH-0626CD05	1 pc.	1" - 5 x Ø26
UFH-0626CD06	1 pc.	1" - 6 x Ø26
UFH-0626CD07	1 pc.	1" - 7 x Ø26

TILL EXHAUSTION OF STOCK





- 1
- 2
- 3
- 4
- 5
- 6
- 7
- 8
- 9
- 10
- 11

Type: UFH-CAB-I



Recessed manifold cabinet, RAL 9016
Verdelerkast voor inbouw, RAL 9016
Boîte à encastrer pour collecteurs, RAL 9016
Verteilerschrank Unterputz, RAL 9016

Article number	Packing	Type
UFH-CAB-I400 *	1 pc.	400x700-800x112-152mm (4 circ.)
UFH-CAB-I600 *	1 pc.	600x700-800x112-152mm (8 circ.)
UFH-CAB-I800 *	1 pc.	800x700-800x112-152mm (12 circ.)
UFH-CAB-I1000 *	1 pc.	1000x700-800x112-152mm (16 circ.)

** Only in combination with brass manifolds*

Type: UFH-CAB-O



Surface mount manifold cabinet, RAL 9016
Verdelerkast voor opbouw, RAL 9016
Boîte à poser pour collecteurs, RAL 9016
Verteilerschrank Aufputz, RAL 9016

Article number	Packing	Type
UFH-CAB-O400 *	1 pc.	400x720x112mm (4 circ.)
UFH-CAB-O600 *	1 pc.	600x720x112mm (8 circ.)
UFH-CAB-O800 *	1 pc.	800x720x112mm (12 circ.)
UFH-CAB-O1000 *	1 pc.	1000x720x112mm (16 circ.)

** Only in combination with brass manifolds*



Press machines, press jaws and calibrating tools should be checked on a regular base when used intensively.

Pressmachines, persbekken en kalibreergereedschap dienen bij intensief gebruik op regelmatige basis gecontroleerd te worden.

Des machines à sertir, des pinces et des outils pour calibrage soumis à un usage intensif doivent être contrôlé régulièrement.

Press Maschinen, Pressbacken und Kalibrierung Werkzeuge sollten auf einer regelmäßigen Basis überprüft werden, wenn intensiv genutzt.



Type: BI



Internal bending spring
Binnenbuigveer
Ressort à plier intérieur
Biegefeder innen

Article number	pc / Box	Type
BI-1410	1 pc. / 100 pc.	14x2 L=50 cm
BI-1612	1 pc. / 100 pc.	16x2 L=50 cm
BI-1612L	1 pc. / 50 pc.	16x2 L=100 cm
BI-1814	1 pc. / 75 pc.	18x2 L=50 cm
BI-2016	1 pc. / 75 pc.	20x2 L=50 cm
BI-2016L	1 pc. / 25 pc.	20x2 L=100 cm
BI-2620	1 pc. / 25 pc.	26x3 L=100 cm

Type: BA



External bending spring
Buitenbuigveer
Ressort à plier extérieur
Biegefeder aussen

Article number	pc / Box	Type
BA-1288	1 pc. / 50 pc.	12x1,88 L=50 cm
BA-1410	1 pc. / 50 pc.	14x2 L=50 cm
BA-1612	1 pc. / 50 pc.	16x2 L=50 cm
BA-1814	1 pc. / 50 pc.	18x2 L=50 cm
BA-2016	1 pc. / 50 pc.	20x2 L=50 cm

Type: BM



Bending tool
Buigijzer
Cintreuse
Biegewerkzeug

Article number	Packing	Type
BM-16	1 pc.	for Ø16
BM-18	1 pc.	for Ø18
BM-20	1 pc.	for Ø20
BM-26	1 pc.	for Ø26

Type: RSPRESS



Guillotine cutter
Guillotineschaar
Pince guillotine
Guillotinezange

Article number	Packing	Type
RS1420PRESS	1 pc.	14 till 20 mm
RS2640PRESS	1 pc.	26 till 40 mm



Type: RSEM-PERS



Replacement blade for art. RS1420PRESS and RS2640PRESS

Vervangmes voor art. RS1420PRESS en RS2640PRESS

Lame pour art. RS1420PRESS et RS2640PRESS

Ersatzmesser für Art. RS1420PRESS UND RS2640PRESS

Article number	Packing	Type
RSEM1420-PERS	1 pc.	14 till 20 mm
RSEM2640-PERS	1 pc.	26 till 40 mm

Type: RSPRESS-N



Guillotine cutter

Guillotineschaar

Pince guillotine

Guillotinezange

Article number	Packing	Type
RS1420PRESS-N	1 pc.	14 till 20 mm

Type: RS



Wheel cutter

Buizensnijder

Coupe-tube

Rohrschneidezange

Article number	Packing	Type
RS32	1 pc.	14 till 32 mm
RS63	1 pc.	14 till 63 mm

Type: RSEM



Replacement wheel for art. RS32 and RS63

Vervangmes voor art. RS32 en RS63

Lame de rechange pour art. RS32 et RS63

Ersatzmesser für Art. RS32 und RS63

Article number	Packing	Type
RSEM32	1 pc.	14 till 32 mm
RSEM63	1 pc.	14 till 63 mm

- 1
- 2
- 3
- 4
- 5
- 6
- 7
- 8
- 9
- 10
- 11



Type: SAFECUT



Cutter to open the packing paper
 Mes om verpakkingspapier te openen
 Couteau pour ouvrir le papier d'emballage
 Schneider zum Öffnen der Packing

Article number	Packing	Type
SAFECUT	1 pc.	SAFECUT

Type: PS-16



Pipe straightener Ø16
 Buizenrechter Ø16
 Redresseur Ø16
 Rohrbegradiger Ø16

Article number	Packing	Type
PS-16	1 pc.	PS

Characteristics PS-16

- ▶ Simplifies installation and reduces labour
- ▶ Easy to use
- ▶ Less material usage and waste
- ▶ Accelerated flow for better efficiencies and reduced running costs
- ▶ Professional looking finish

Type: KS-MSET1



Set with KS-K and KS-M for Ø16, 20 and 26
 Set met KS-K en KS-M voor Ø16, 20 en 26
 Set avec KS-K et KS-M pour Ø16, 20 et 26
 Set mit KS-K und KS-M für Ø16, 20 und 26

Article number	Packing	Type
KS-MSET1	1 pc.	MSET1

Type: KS-MSET4



Set with KS-K and KS-M for Ø16, 20, 26 and 32
 Set met KS-K en KS-M voor Ø16, 20, 26 en 32
 Set avec KS-K et KS-M pour Ø16, 20, 26 et 32
 Set mit KS-K und KS-M für Ø16, 20, 26 und 32

Article number	Packing	Type
KS-MSET4	1 pc.	MSET4



Type: KS



Kalispeed for electric drills (max. 500 rpm, clockwise only)
 Kalispeed voor accu-boormachine (max. 500 toeren, rechts draaien verplicht)
 Kalispeed pour perceuses à batterie (max. 500 tournages, obligation de tourner à droite)
 Kalispeed für Akku-Bohrmaschine (max. 500 Drehungen, rechts drehen verpflichtet)

Article number	Packing	Type
KS50	1 pc.	for Ø50
KS63	1 pc.	for Ø63

Type: KS-M



Kalispeed, metal, for KS-K and electric drills (max. 500 rpm, clockwise only)
 Kalispeed, metaal, voor KS-K en accu-boormachine (max. 500 toeren, rechts draaien verplicht)
 Kalispeed, métal, pour KS-K et perceuses à batterie (max. 500 tours, obligation de tourner à droite)
 Kalispeed, Metall, für KS-K und Akku-Bohrmaschine (max. 500 Drehungen, rechts drehen verpflichtet)

Article number	Packing	Type
KS12M	1 pc.	for Ø12
KS14M	1 pc.	for Ø14
KS16M	1 pc.	for Ø16
KS18M	1 pc.	for Ø18
KS20M	1 pc.	for Ø20
KS26M	1 pc.	for Ø26
KS32M	1 pc.	for Ø32
KS40M	1 pc.	for Ø40

Type: KS-K



Clickhandle for KS (Kalispeed)
 Klikhandvat voor KS (Kalispeed)
 Manche clic pour KS (Kalispeed)
 Klickgriff für KS (Kalispeed)

Article number	Packing	Type
KS-K	1 pc.	up to Ø26 mm

Type: KS-P



Kalispeed for Ø16, 20 and 26
 Kalispeed voor Ø16, 20 en 26
 Kalispeed pour Ø16, 20 et 26
 Kalispeed für Ø16, 20 und 26

Article number	Packing	Type
KS-P162026	1 pc.	for Ø16, 20 and 26

Not for intensive use



Type: PH-1632



Pipe holder for diameters 16-20-26-32
 Griptang voor buis diameter 16-20-26-32
 Pince de maintien diamètre 16-20-26-32
 Rohrhalter für Diameter 16-20-26-32

Article number	Packing	Type
PH-1632	1 pc.	up to 32 mm

Characteristics PH-1632

- ▶ Always sufficient grip when calibrating short pipe ends
- ▶ Prevents the pipe from turning too during calibration
- ▶ Inspired by the classic nutcracker model
- ▶ Henco blue anodised aluminium
- ▶ Lightweight tool
- ▶ Suitable for pipe diameters of 16 –20 –26 –32



Type: M-BA03



Kit: battery press machine including battery + charge unit + case, linear drive 32 kN, up to Ø 63

Kit: accu-persmachine + accu + lader + koffer, lineaire aandrijving 32 kN, tot Ø 63

Kit: machine à sertir + batterie + chargeur + coffret, propulsion linéaire 32 kN, jusqu'à Ø 63

Kit: Akku-Pressmaschine, lineare Schubkraft 32 kN, bis Ø 63

Article number	Packing	Type
M-BA03	1 pc.	BA03

Type: M-BAT03



Battery for M-BA03

Accu voor M-BA03

Batterie pour M-BA03

Akku für M-BA03

Article number	Packing	Type
M-BAT03	1 pc.	BAT03



Type: M-LAD03



Charge-unit for M-BA03, M-BMINI2
Lader voor M-BA03, M-BMINI2
Chargeur pour M-BA03, M-BMINI2
Akku-Ladegerät für M-BA03, M-BMINI2

Article number	Packing	Type
M-LAD03	1 pc.	LAD03

Type: M-TRANS03



Mains Adapter for M-BA03
Adapter voor netaansluiting voor M-BA03
Adaptateur raccordement au réseau pour M-BA03
Netzadapter für M-BA03I

Article number	Packing	Type
M-TRANS03	1 pc.	TRANS03

Type: M-BOXBA03



Case for M-BA03
Koffer voor M-BA03
Coffret pour M-BA03
Koffer für M-BA03

Article number	Packing	Type
M-BOXBA03	1 pc.	BOX M-BA03

- 1
- 2
- 3
- 4
- 5
- 6
- 7
- 8
- 9
- 10
- 11



1
2
3
4
5
6
7
8
9
10
11

Type: M-BHY162026



Kit : 230 volt hydraulic press machine with 16, 20, 26 jaws + metal case (110 volt also available), linear drive 32 to 40 kN

Kit : Elektrisch-hydraulische persmachine + bekken 16, 20, 26 + koffer, liniaire aandrijving 32 tot 40kN

Kit: machine à sertir électro-hydraulique + pinces 16, 20, 26 + coffret, propulsion linéaire 32 jusqu'à 40 kN

Kit : Elektrohydraulische Pressmaschine + Pressbacken 16, 20, 26 + Koffer, lineare Schubkraft 32 bis 40 kN

Article number	Packing	Type
M-BHY162026	1 pc.	Ø14-63

Type: M-BHY



Kit : 230 volt hydraulic press machine + metal case (110 volt also available), linear drive 32 to 40 kN

Kit : Elektrisch-hydraulische persmachine + koffer, liniaire aandrijving 32 tot 40kN

Kit: machine à sertir électro-hydraulique + coffret, propulsion linéaire 32 jusqu'à 40 kN

Kit : Elektrohydraulische Pressmaschine + Koffer, lineare Schubkraft 32 bis 40 kN

Article number	Packing	Type
M-BHY	1 pc.	Ø14-63

Type: M-BOXBHY



Metal case for M-BHY162026

Koffer voor M-BHY162026

Coffret en métal pour M-BHY162026

Koffer für M-BHY162026

Article number	Packing	Type
M-BOXBHY	1 pc.	Ø14-63



Type: BE



Jaws (universal)
 Persbekken (universeel)
 Pincés à sertir (universel)
 Pressbacken (universal)

Article number	Packing	Type
BE14	1 pc.	BE/TH 14x2
BE16	1 pc.	BE/TH 16x2
BE18	1 pc.	BE/TH 18x2
BE20	1 pc.	BE/TH 20x2
BE26	1 pc.	BE/TH 26x3
BE32	1 pc.	BE 32x3
BE40	1 pc.	BE 40x3,5
BE50	1 pc.	BE 50x4
BE63	1 pc.	BE 63x4,5

Type: BE-UNISET1



Set with universal jaw mounting unit and BE-H inserts Ø16, 20 and 26
 Set met universele moederbekken en wisselbekken BE-H Ø16, 20, 26
 Set avec pince mère universel et pincés BE-H Ø16, 20, 26
 Set mit Mutterpressbacke universal und Backen BE-H Ø16, 20, 26

Article number	Packing	Type
BE-UNISET1	1 pc.	UNISET1

Press tool compatibility: see technical manual

Type: BE-UNISET2



Set with universal jaw mounting unit and BE-H inserts Ø14, 16, 18, 20, 26, and 32
 Set met universele moederbek en wisselbekken BE-H Ø14, 16, 18, 20, 26 en 32
 Set avec pince mère universel et pincés BE-H Ø14, 16, 18, 20, 26, et 32
 Set mit Mutterpressbacke universal und Backen BE-H Ø14, 16, 18, 20, 26, und 32

Article number	Packing	Type
BE-UNISET2	1 pc.	UNISET2

Press tool compatibility: see technical manual



Type: TOOLBOX16202632



Box with KS16 20 26 32 M, BE-UNI, BE16 20 26 32 H, BI-1612, BI-2016, BA-1612, BA-2016, RS1420PRESS, SAFECUT
 Koffer met KS16 20 26 32 M, BE-UNI, BE16 20 26 32 H, BI-1612, BI-2016, BA-1612, BA-2016, RS1420PRESS, SAFECUT
 Coffre avec KS16 20 26 32 M, BE-UNI, BE16 20 26 32 H, BI-1612, BI-2016, BA-1612, BA-2016, RS1420PRESS, SAFECUT
 Koffer mit KS16 20 26 32 M, BE-UNI, BE16 20 26 32 H, BI-1612, BI-2016, BA-1612, BA-2016, RS1420PRESS, SAFECUT

Article number	Packing	Type
TOOLBOX16202632	1 pc.	TOOLBOX16202632

Type: TOOLBOX405063



Box with KS40M, KS50, KS63, BE40 50 63, RS63
 Koffer met KS40M, KS50, KS63, BE40 50 63, RS63
 Coffre avec KS40M, KS50, KS63, BE40 50 63, RS63
 Koffer mit KS40M, KS50, KS63, BE40 50 63, RS63

Article number	Packing	Type
TOOLBOX405063	1 pc.	TOOLBOX405063

Type: BE-UNI



Jaw mounting unit for M-BA03 and M-BHY, to be used with BE-H jaws
 Moederbek voor M-BA03 en M-BHY en te gebruiken met BE-H bekken
 Pince mère pour M-BA03 et M-BHY, à utiliser avec pinces BE-H
 Mutterpressbacke für M-BA003 und M-BHY, zu verwenden mit BE-H Backen

Article number	Packing	Type
BE-UNI	1 pc.	BE-UNI

Press tool compatibility: see technical manual

BE-UNI is designed to press Henco press fittings, the interchangeable dies with M- and V-profile make it possible to make the transition from other materials to Henco; other than Henco branded fittings with compact measurements can cause complex manipulation.



Type: BE-H



Inserts for BE-UNI, BE-MINI2, BE-MINI3, M-BH
 Wisselbekken voor BE-UNI, BE-MINI2, BE-MINI3, M-BH
 Pincas pour BE-UNI, BE-MINI2, BE-MINI3, M-BH
 Pressbacken für BE-UNI, BE-MINI2, BE-MINI3, M-BH

Article number	Packing	Type
BE14H	1 Set (2 pc.)	BE/TH 14X2 H
BE16H	1 Set (2 pc.)	BE/TH 16X2 H
BE18H	1 Set (2 pc.)	BE/TH 18X2 H
BE20H	1 Set (2 pc.)	BE/TH 20X2 H
BE26H	1 Set (2 pc.)	BE/TH 26X3 H
BE32H	1 Set (2 pc.)	BE 32X3 H

Type: BE-HC



Inserts (copper) for BE-UNI, BE-MINI2, M-BH, BE-MINI3
 Wisselbekken (koper) voor BE-UNI, BE-MINI2, M-BH, BE-MINI3
 Pincas (cuivre) pour BE-UNI, BE-MINI2, M-BH, BE-MINI3
 Pressbacken (Kupfer) für BE-UNI, BE-MINI2, M-BH, BE-MINI3

Article number	Packing	Type
BE12HC	1 Set (2 pc.)	12Cu V-profile
BE14HC	1 Set (2 pc.)	14Cu V-profile
BE15HC	1 Set (2 pc.)	15Cu V-profile
BE16HC	1 Set (2 pc.)	16Cu V-profile
BE18HC	1 Set (2 pc.)	18Cu V-profile
BE22HC	1 Set (2 pc.)	22Cu V-profile
BE28HC	1 Set (2 pc.)	28Cu V-profile

Type: BE-HM



Inserts (copper) for BE-UNI, BE-MINI2, M-BH, BE-MINI3
 Wisselbekken (koper) voor BE-UNI, BE-MINI2, M-BH, BE-MINI3
 Pincas (cuivre) pour BE-UNI, BE-MINI2, M-BH, BE-MINI3
 Pressbacken (Kupfer) für BE-UNI, BE-MINI2, M-BH, BE-MINI3

Article number	Packing	Type
BE12HM	1 Set (2 pc.)	12Cu M-profile
BE15HM	1 Set (2 pc.)	15Cu M-profile
BE18HM	1 Set (2 pc.)	18Cu M-profile
BE22HM	1 Set (2 pc.)	22Cu M-profile

Type: BE-BOX



Metal case for 4 compression jaws
 Stalen koffer voor 4 persbekken
 Coffret en métal pour 4 pincas à sertir
 Stahlblechkasten für 4 Pressbacken

Article number	Packing	Type
BE-BOX	1 pc.	BOX



Type: M-BMINI3-F



Kit : compact rechargeable battery press machine with press monitoring + case + charge unit + battery 18V + full jaws TH16-20-26, linear drive ca. 19 kN

Kit: hydraulische accu-persmachine met persbewaking + koffer + lader + 1 accu 18V + volle bekken TH16-20-26, lineaire aandrijving ca. 19kN

Kit : machine à sertir hydraulique + boîte + chargeur + batterie 18V, pince TH16-20-26, propulsion linéaire ca.19 kN

Kit: Hydraulisches Akku-Presswerkzeug mit Pressdrucküberwachung + Koffer + Ladegerät + 1 Akku 18V + Pressbacken TH16-20-26, lineare Schubkraft ca. 19 kN

Article number	Packing	Type
M-BMINI3-F	1 pc.	Ø16-26 / 18V

Type: M-BMINI3



Kit : compact rechargeable battery press machine with press monitoring + case + charge unit + battery 18V + mother jaw + inserts TH16-20-26, linear drive ca. 19 kN

Kit: hydraulische accu-persmachine met persbewaking + koffer + lader + 1 accu 18V + moederbek met inserts TH16-20-26, lineaire aandrijving ca. 19kN

Kit : machine à sertir hydraulique + boîte + chargeur + batterie 18V + pince mère + inserts TH16-20-26, propulsion linéaire ca.19 kN

Kit: Hydraulisches Akku-Presswerkzeug mit Pressdrucküberwachung + Koffer + Ladegerät + 1 Akku 18V + Mutterpressbacke und Pressbacken TH16-20-26, lineare Schubkraft ca. 19 kN

Article number	Packing	Type
M-BMINI3	1 pc.	Ø16-26 / 18V

Type: M-BMINI3-S



Kit : compact rechargeable battery press machine with press monitoring + case + charge unit + battery 18V, linear drive ca. 19 kN

Kit: hydraulische accu-persmachine met persbewaking + koffer + lader + 1 accu 18V, lineaire aandrijving ca. 19kN

Kit : machine à sertir hydraulique + boîte + chargeur + batterie 18V, propulsion linéaire ca.19 kN

Kit: Hydraulisches Akku-Presswerkzeug mit Pressdrucküberwachung + Koffer + Ladegerät + 1 Akku 18V, lineare Schubkraft ca. 19 kN

Article number	Packing	Type
M-BMINI3-S	1 pc.	Ø16-26 / 18V



Type: M-BATMINI3



Battery 18V for M-BMINI3-F, M-BMINI3, M-BMINI3-S
 Accu 18V voor M-BMINI3-F, M-BMINI3, M-BMINI3-S
 Batterie 18V pour M-BMINI3-F, M-BMINI3, M-BMINI3-S
 Akku 18V für M-BMINI3-F, M-BMINI3, M-BMINI3-S

Article number	Packing	Typ
M-BATMINI3-1.5AH	1 pc.	18V / 1,5 Ah Li-ion
M-BATMINI3-3.0AH	1 pc.	18V / 3,0 Ah Li-ion

Type: M-LADMINI3



Charge-unit for M-BMINI3-F, M-BMINI3, M-BMINI3-S
 Lader voor M-BMINI3-F, M-BMINI3, M-BMINI3-S
 Chargeur pour M-BMINI3-F, M-BMINI3, M-BMINI3-S
 Akku-Ladegerät für M-BMINI3-F, M-BMINI3, M-BMINI3-S

Article number	Packing	Type
M-LADMINI3	1 pc.	for M-BATMINI3

Type: M-TRANSMINI3



Mains Adapter for M-BMINI3-F, M-BMINI3, M-BMINI3-S + 5m cable
 Adapter voor netaansluiting M-BMINI3-F, M-BMINI3, M-BMINI3-S + 5m kabel
 Adapteur raccordement au réseau M-BMINI3-F, M-BMINI3, M-BMINI3-S + 5m cable
 Netzadapter für M-BMINI3-F, M-BMINI3, M-BMINI3-S + 5m Kabel

Article number	Packing	Type
M-TRANSMINI3	1 pc.	18V / 230V

Type: M-BOXMINI3



Metal case for M-BMINI3, M-BMINI3-S
 Koffer in metaal voor M-BMINI3, M-BMINI3-S
 Coffret en métal pour M-BMINI3, M-BMINI3-S
 Koffer in Metal für M-BMINI3, M-BMINI3-S

Article number	Packing	Type
M-BOXMINI3	1 pc.	M-BOXMINI3

- 1
- 2
- 3
- 4
- 5
- 6
- 7
- 8
- 9
- 10
- 11



Type: M-BOXMINI3-F



Metal case for M-BMINI3-F
 Koffer in metaal voor M-BMINI3-F
 Coffret en métal pour M-BMINI3-F
 Koffer in Metal für M-BMINI3-F

Article number	Packing	Type
M-BOXMINI3-F	1 pc.	M-BOXMINI3-F

Type: BE-MINI3



Mother jaw press machine M-BMINI3 with BE-H inserts
 Moederbek voor persmachine M-BMINI3 met BE-H inserts
 Pince mère pour machine à sertir M-BMINI3 avec pinces BE-H
 Mutterpressbacke für Presswerkzeuge M-BMINI3, zu verwenden mit BE-H backen

Article number	Packing	Type
BE-MINI3	1 pc.	BE-MINI3

Type: BE..-MINI3



Jaw for press machine M-BMINI3 - TH profile
 Bek voor persmachine M-BMINI3 - TH profiel
 Pince pour machine à sertir M-BMINI3 - Profil TH
 Pressbacke für Presswerkzeuge M-BMINI3 + Profil TH

Article number	Packing	Type
BE14MINI3	1 pc.	BE/TH Ø14
BE16MINI3	1 pc.	BE/TH Ø16
BE20MINI3	1 pc.	BE/TH Ø20
BE26MINI3	1 pc.	BE/TH Ø26
BE32MINI3	1 pc.	BE/TH Ø32

Type: BE.V-MINI3



Jaw for press machine M-BMINI3 - V profile
 Bek voor persmachine M-BMINI3 - V profiel
 Pince pour machine à sertir M-BMINI3 - Profil V
 Pressbacke für Presswerkzeuge M-BMINI3 + Profil V

Article number	Packing	Type
BE15V-MINI3	1 pc.	V-profile 15mm
BE18V-MINI3	1 pc.	V-profile 18mm
BE22V-MINI3	1 pc.	V-profile 22mm
BE28V-MINI3	1 pc.	V-profile 28mm



Type: BE.M-MINI3



Jaw for press machine M-BMINI3 - M profile
 Bek voor persmachine M-BMINI3 - M profiel
 Pince pour machine à sertir M-BMINI3 - Profil M
 Pressbacke für Presswerkzeuge M-BMINI3 + Profil M

Article number	Packing	Type
BE12M-MINI3	1 pc.	M-profile 12mm
BE15M-MINI3	1 pc.	M-profile 15mm
BE18M-MINI3	1 pc.	M-profile 18mm
BE22M-MINI3	1 pc.	M-profile 22mm
BE28M-MINI3	1 pc.	M-profile 28mm

Type: M-BMINI2-SLB



Kit : compact rechargeable battery press machine with press monitoring + case, linear drive ca. 15 kN
 Kit: hydraulische accu-persmachine met persbewaking + kunststofkoffer, lineaire aandrijving ca. 15kN
 Kit : machine à sertir hydraulique + boîte en plastique, propulsion linéaire ca.15 kN
 Kit: Hydraulisches Akku-Presswerkzeug mit Pressdrucküberwachung + Kunststoffkoffer, lineare Schubkraft ca. 15 kN

Article number	Packing	Type
M-BMINI2-SLB	1 pc.	Ø14-32, 18V / 1,5 Ah Li-ion

Type: M-BATMINI2



Battery 18V / 1,5 Ah Li-ion for M-BMINI2
 Accu 18V / 1,5 Ah Li-ion voor M-BMINI2
 Batterie 18V / 1,5 Ah Li-ion pour M-BMINI2
 Akku 18V / 1,5 Ah Li-ion für M-BMINI2

Article number	Packing	Typ
M-BATMINI2	1 pc.	18V / 1,5 Ah Li-ion

Type: M-TRANSMINI2



Mains Adapter for M-BMINI2(S)
 Adapter voor netaansluiting M-BMINI2(-S)
 Adapteur raccordement au réseau M-BMINI2(-S)
 Netzadapter für M-BMINI2(-S)

Article number	Packing	Type
M-TRANSMINI2	1 pc.	18V / 230V

- 1
- 2
- 3
- 4
- 5
- 6
- 7
- 8
- 9
- 10
- 11



Type: M-BOXMINI2



Case for M-BMINI2(-S)
Koffer voor M-BMINI2(-S)
Coffret pour M-BMINI2(-S)
Koffer für M-BMINI2(-S)

Article number	Packing	Type
M-BOXMINI2	1 pc.	M-BOXMINI2

Type: BE..-MINI



Jaw for press machine M-BMINI2(-S) and M-HP32
Bek voor persmachine M-BMINI2(-S) en M-HP32
Pince pour machine à sertir M-BMINI2(-S) et M-HP32
Pressbacke für Presswerkzeuge M-BMINI2(-S) und M-HP32

Article number	Packing	Type
BE16MINI	1 pc.	BE/TH Ø16
BE20MINI	1 pc.	BE/TH Ø20
BE26MINI	1 pc.	BE/TH Ø26
BE32MINI	1 pc.	BE Ø32

Type: BE..-MMINI



M-profile jaw (copper) for press machine M-BMINI2(-S) and M-HP32
M-profiel bek (koper) voor persmachine M-BMINI2(-S) en M-HP32
M-profil pincen (cuivre) pour machine à sertir M-BMINI2(-S) et M-HP32
M-profil Pressbacke (Kupfer) für Presswerkzeuge M-BMINI2(-S) und M-HP32

Article number	Packing	Type
BE15MMINI	1 pc.	Ø15Cu M-Profile
BE22MMINI	1 pc.	Ø22Cu M-Profile



Type: BE-C



V-profile jaw (copper) for press machine M-BMINI2(-S) and M-HP32
V-profiel bek (koper) voor persmachine M-BMINI2(-S) en M-HP32
V-profil pinces (cuivre) pour machine à sertir M-BMINI2(-S) et M-HP32
V-profil Pressbacke (Kupfer) für Presswerkzeuge M-BMINI2(-S) und M-HP32

Article number	Packing	Type
BE15C	1 pc.	Ø15Cu V-Profile
BE18C	1 pc.	Ø18Cu V-Profile
BE22C	1 pc.	Ø22Cu V-Profile
BE28C	1 pc.	Ø28Cu V-Profile

Type: BE-MINI



Jaw mounting unit for press machine M-BMINI2(-S) / M-HP32 and to be used with BE-H jaws
Moederbek voor persmachine M-BMINI2(-S) / M-HP32 en te gebruiken met BE-H bekken
Pince mère pour machine à sertir M-BMINI2(-S) / M-HP32 et à utiliser avec pinces BE-H
Mutterpressbacke für Presswerkzeug M-BMINI2(-S) / M-HP32, zu verwenden mit BE-H Backen

Article number	Packing	Type
BE-MINI	1 pc.	BE-MINI

BE-MINI is designed to press Henco press fittings, the interchangeable dies with M- and V-profile make it possible to make the transition from other materials to Henco; other than Henco branded fittings with compact measurements can cause complex manipulation

Type: BE-H



Inserts for BE-UNI, BE-MINI2, BE-MINI3, M-BH
Wisselbekken voor BE-UNI, BE-MINI2, BE-MINI3, M-BH
Pinces pour BE-UNI, BE-MINI2, BE-MINI3, M-BH
Pressbacken für BE-UNI, BE-MINI2, BE-MINI3, M-BH

Article number	Packing	Type
BE14H	1 Set (2 pc.)	BE/TH 14X2 H
BE16H	1 Set (2 pc.)	BE/TH 16X2 H
BE18H	1 Set (2 pc.)	BE/TH 18X2 H
BE20H	1 Set (2 pc.)	BE/TH 20X2 H
BE26H	1 Set (2 pc.)	BE/TH 26X3 H
BE32H	1 Set (2 pc.)	BE 32X3 H



Type: BE-HC



Inserts (copper) for BE-UNI, BE-MINI2, M-BH, BE-MINI3
 Wisselbekken (koper) voor BE-UNI, BE-MINI2, M-BH, BE-MINI3
 Pincas (cuivre) pour BE-UNI, BE-MINI2, M-BH, BE-MINI3
 Pressbacken (Kupfer) für BE-UNI, BE-MINI2, M-BH, BE-MINI3

Article number	Packing	Type
BE12HC	1 Set (2 pc.)	12Cu V-profile
BE14HC	1 Set (2 pc.)	14Cu V-profile
BE15HC	1 Set (2 pc.)	15Cu V-profile
BE16HC	1 Set (2 pc.)	16Cu V-profile
BE18HC	1 Set (2 pc.)	18Cu V-profile
BE22HC	1 Set (2 pc.)	22Cu V-profile
BE28HC	1 Set (2 pc.)	28Cu V-profile

Type: BE-HM



Inserts (copper) for BE-UNI, BE-MINI2, M-BH, BE-MINI3
 Wisselbekken (koper) voor BE-UNI, BE-MINI2, M-BH, BE-MINI3
 Pincas (cuivre) pour BE-UNI, BE-MINI2, M-BH, BE-MINI3
 Pressbacken (Kupfer) für BE-UNI, BE-MINI2, M-BH, BE-MINI3

Article number	Packing	Type
BE12HM	1 Set (2 pc.)	12Cu M-profile
BE15HM	1 Set (2 pc.)	15Cu M-profile
BE18HM	1 Set (2 pc.)	18Cu M-profile
BE22HM	1 Set (2 pc.)	22Cu M-profile

Type: M-HP



Hydraulic manual press tool + bag
 Hydraulisch handpersmachine + draagtas
 Machine à sertir manuelle hydraulique + sac
 Hydraulisches Handpressmaschine + Tasche

Article number	Packing	Type
M-HP32	1 pc.	Ø14-32

Type: M-BH



Kit: manual press machine + inserts 16,20,26 + bag
 Kit: handpersmachine + bken 16, 20, 26 + draagtas
 Kit: machine à sertir manuelle + pinces 16, 20, 26 + sac
 Kit: Handpersmaschine + Pressbacken 16, 20, 26 + Tasche

Article number	Packing	Type
M-BH162026	1 pc.	BH 16x2 / 20x2 / 26x3



Type: BE-H



Inserts for BE-UNI, BE-MINI2, BE-MINI3, M-BH
 Wisselbekken voor BE-UNI, BE-MINI2, BE-MINI3, M-BH
 Pincas pour BE-UNI, BE-MINI2, BE-MINI3, M-BH
 Pressbacken für BE-UNI, BE-MINI2, BE-MINI3, M-BH

Article number	Packing	Type
BE14H	1 Set (2 pc.)	BE/TH 14X2 H
BE16H	1 Set (2 pc.)	BE/TH 16X2 H
BE18H	1 Set (2 pc.)	BE/TH 18X2 H
BE20H	1 Set (2 pc.)	BE/TH 20X2 H
BE26H	1 Set (2 pc.)	BE/TH 26X3 H
BE32H	1 Set (2 pc.)	BE 32X3 H

Type: BE-HC



Inserts (copper) for BE-UNI, BE-MINI2, M-BH, BE-MINI3
 Wisselbekken (koper) voor BE-UNI, BE-MINI2, M-BH, BE-MINI3
 Pincas (cuivre) pour BE-UNI, BE-MINI2, M-BH, BE-MINI3
 Pressbacken (Kupfer) für BE-UNI, BE-MINI2, M-BH, BE-MINI3

Article number	Packing	Type
BE12HC	1 Set (2 pc.)	12Cu V-profile
BE14HC	1 Set (2 pc.)	14Cu V-profile
BE15HC	1 Set (2 pc.)	15Cu V-profile
BE16HC	1 Set (2 pc.)	16Cu V-profile
BE18HC	1 Set (2 pc.)	18Cu V-profile
BE22HC	1 Set (2 pc.)	22Cu V-profile
BE28HC	1 Set (2 pc.)	28Cu V-profile

Type: BE-HM



Inserts (copper) for BE-UNI, BE-MINI2, M-BH, BE-MINI3
 Wisselbekken (koper) voor BE-UNI, BE-MINI2, M-BH, BE-MINI3
 Pincas (cuivre) pour BE-UNI, BE-MINI2, M-BH, BE-MINI3
 Pressbacken (Kupfer) für BE-UNI, BE-MINI2, M-BH, BE-MINI3

Article number	Packing	Type
BE12HM	1 Set (2 pc.)	12Cu M-profile
BE15HM	1 Set (2 pc.)	15Cu M-profile
BE18HM	1 Set (2 pc.)	18Cu M-profile
BE22HM	1 Set (2 pc.)	22Cu M-profile

Type: M-BM1620



Kit: manual press machine with 16, 20 jaws
 Kit: handpersmachine + wisselbekken 16, 20
 Kit: machine à sertir manuelle + pincas 16, 20
 Kit: Handpressmaschine + Pressbacken 16, 20

Article number	Packing	Type
M-BM1620	1 pc.	BM 16x2 / 20x2



Type: BE-M



Inserts for M-BM1620
 Wisselbekken voor M-BM1620
 Pincés pour M-BM1620
 Pressbacken für M-BM1620

Article number	Packing	Type
BE14M	1 Set (2 pc.)	BE 14X2 M
BE16M	1 Set (2 pc.)	BE 16X2 M
BE18M	1 Set (2 pc.)	BE 18X2 M
BE20M	1 Set (2 pc.)	BE 20X2 M

Type: PRESSCHECK



Tool to control the accuracy of a pressing
 Instrument om correctheid v/e persing te controleren
 Outil pour contrôler la précision d'un sertissage
 Instrument zur Überprüfung ob die Pressung korrekt ausgeführt

Article number	Packing	Type
PRESSCHECK1432	1 pc.	Ø14-32

Type: DRILLY



Drilly temporary air vent plug, reusable
 Drilly voor afdrukken leidingssysteem, herbruikbaar
 Drilly pour tester le système de tubes, réutilisable
 Drilly zum abdrukken Rohresysteme, wieder verwendbar

Article number	Packing	Type
DRILLY14	1 pc.	Ø14
DRILLY16	1 pc.	Ø16
DRILLY20	1 pc.	Ø20
DRILLY26	1 pc.	Ø26
DRILLY32	1 pc.	Ø32

Type: PLUG



Plug
 Afdrukplug
 Bouchon
 Stopf

Article number	Packing	Type
PLUG04-B80	20 pc.	1/2" - 80 mm blue
PLUG04-R80	20 pc.	1/2" - 80 mm red
PLUG05-B80	20 pc.	3/4" - 80 mm blue
PLUG05-R80	20 pc.	3/4" - 80 mm red



Type: UFH-VLA



Decoiler, standard model
 Haspel, basismodel
 Machine à dérouler, standard
 Abwickelmaschine, Standard

Article number	Packing	Type
UFH-VLA	1 pc.	25 m - 600 m

Minimum inner diameter coil: 140mm

Type: UFH-VLA-STR



Pipe straightener for decoiler UFH-VLA 14-26 mm
 Stangenrechter voor haspel UFH-VLA 14-26 mm
 Machine à produire des barres pour dérouleur UFH-VLA 14-26 mm
 Stangenmaschine für Wichelmaschine UFH-VLA 14-26 mm

Article number	Packing	Type
UFH-VLA-STR	1 pc.	

Type: UFH-RAS-VLE



Braid hook
 Vlechthaak
 Crochet de tressage
 Gerät zum Flechten von Stahldraht

Article number	Packing	Type
UFH-RAS-VLE	1 pc.	

Type: UFH-RAS-CUT



Cutter for steel mesh
 Kniptang voor stalen draadmatten
 Pince coupante pour treillis
 Schere für Trägermatte

Article number	Packing	Type
UFH-RAS-CUT	1 pc.	

- 1
- 2
- 3
- 4
- 5
- 6
- 7
- 8
- 9
- 10
- 11



Type: HNTOOLSET



Toolset for the Super Size range
 Toolset voor het Super Size assortiment
 Toolset pour la gamme Super Size
 Toolset für das Super Size Angebot

Article number	pc	Type
HNTOOLSET	1 pc.	Super Size

Type: PK-TOOL



Wrench for PK/SK fittings with threading
 Sleutel voor PK/SK fittings met draad
 Clé pour raccords PK/SK filtage
 Schlüssel für PK/SK Fittings mit Draht

Article number	Packing	Type
PK-TOOL04	1 pc.	1/2"
PK-TOOL05	1 pc.	3/4"
PK-TOOL06	1 pc.	1"

Type: PK-TOOLBOX040506



Set wrenches for PK/SK fittings 1/2" - 1" threading
 Set sleutels voor PK/SK fittings 1/2" tot 1" draad
 Set clés pour raccords PK/SK filtage 1/2" - 1"
 Set Schlüssel für PK/SK Fittings 1/2" bis 1" Draht

Article number	Packing	Type
PK-TOOL- BOX040506	1 pc.	

Type: PK-TOOLBOX



Empty plastic case for PK-TOOL04/05/06
 Lege koffer voor PK-TOOL04/05/06
 Coffret pour PK-TOOL04/05/06
 Koffer für PK-TOOLBOX04/05/06

Article number	pc	Type
PK-TOOLBOX	1 pc.	

Characteristics PK-TOOL

- ▶ Light weight ratchet key
- ▶ Full grip around fitting profile
- ▶ Plastic body stays intact, even when applying extreme torque
- ▶ Key works as well in clock- as counterclockwise direction
- ▶ Maximum torque transition
- ▶ Size indication on handle
- ▶ Chromed handle
- ▶ Key gripping jaws in anodized aluminum
- ▶ Possibility to grip around mounted fittings due to specific closing mechanism







- 1
- 2
- 3
- 4
- 5
- 6
- 7
- 8
- 9
- 10
- 11

Type: BCLIP



Clip-it clip for Henco pipes, single
 Clip-it beugel voor Henco buizen, enkel
 Clip-it attache de fixation pour tubes henco, simple
 Clip-it Bügel für Henco Rohre, einfach

Article number	Box	Type
BCLIP-14 *	100 pc.	Ø14
BCLIP-16	100 pc.	Ø16
BCLIP-1820	100 pc.	Ø18 - 20
BCLIP-26	100 pc.	Ø26
BCLIP-32 *	100 pc.	Ø32
BCLIP-40 *	100 pc.	Ø40
BCLIP-50 *	50 pc.	Ø50

* TILL EXHAUSTION OF STOCK

Type: JCLIP



J-clip pipe clips, single
 J-clip beugels, enkel
 Attaches de fixation J-clip, simple
 J-clip Haken, einfach

Article number	Box	Type
JCLIP-1632	200 pc.	Ø16-32, 70 mm

Type: JCLIP L



J-clip pipe clips, single
 J-clip beugels, enkel
 Attaches de fixation J-clip, simple
 J-clip Haken, einfach

Article number	Box	Type
JCLIP-1632L	200 pc.	Ø16-32, 97 mm

Type: JCLIP DOUBLE



J-clip pipe clips, double
 J-clip beugels, dubbel
 Attaches de fixation J-clip, double
 J-clip Haken, doppelt

Article number	Box	Type
JCLIP-1632D	200 pc.	Ø16-32, 70 mm



Type: JCLIP DOUBLE L



J-clip pipe clips, double
 J-clip beugels, dubbel
 Attaches de fixation J-clip, double
 J-clip Haken, doppelt

Article number	Box	Type
JCLIP-1632DL	200 pc.	Ø16-32, 97 mm

Type: NCLIP



N-clip pipe clips, single
 N-clip beugels, enkel
 Attaches de fixation N-clip, simple
 N-clip Haken, einfach

Article number	Box	Type
NCLIP-1618	500 pc.	Ø16-18, 55 mm
NCLIP-20	250 pc.	Ø20 + Ø14, 16, 18 with protection hose
NCLIP-26	250 pc.	Ø26, 55 mm

TILL EXHAUSTION OF STOCK

Type: NCLIP DOUBLE



N-clip pipe clips, double
 N-clip beugels, dubbel
 Attaches de fixation N-clip, double
 N-clip Haken, doppelt

Article number	Box	Type
NCLIP-20 DOUBLE	250 pc.	Ø20 + Ø14, 16, 18 with protection hose

TILL EXHAUSTION OF STOCK

Type: PIPEPLUG



Protection cap for pipe
 Beschermstopje voor buis
 Capuchon de protection pour tube
 Schutzkappe für Rohr

Article number	Bag / Box	Type
PIPEPLUG16	100 pc. / 700 pc.	Ø 16

- 1
- 2
- 3
- 4
- 5
- 6
- 7
- 8
- 9
- 10
- 11

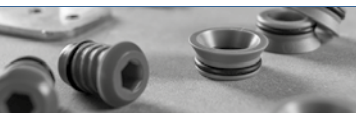

Type: PLP-P-PK



Galvanised bracket for backplate elbow
 Gebogen tappuntbeugel gegalvaniseerd
 Support galvanisé pour culasse sanitaire
 Halteplatte galvanisiert

Article number	Bag / Box	Type
PLP-P-PK	1 pc. / 30 pc.	

Interaxis 153mm

Type: PLF-P-PK



Galvanised bracket flat for backplate elbow
 Vlakke tappuntbeugel gegalvaniseerd
 Support galvanisé pour culasse sanitaire
 Halteplatte flach galvanisiert

Article number	Bag / Box	Type
PLF-P-PK	1 pc. / 80 pc.	

Interaxis 120mm and 153mm

Type: TESTPLUG



Test cap for pipe
 Afdicht/test stopje voor buis
 Capuchon de test pour tube
 Testkappe für Rohr

Article number	Bag / Box	Type
TESTPLUG16	20 pc. / 4000 pc.	
TESTPLUG20	20 pc. / 2000 pc.	
TESTPLUG26	20 pc. / 2000 pc.	

Type: AK-EK



Adapter from EK 3/4" to flat sealing
 Adapter kunststof EK 3/4" naar vlakdichtend
 Adaptateur EK 3/4" vers joint plat
 Adapter von EK 3/4" nach AG flachdichtend

Article number	Bag / Box	Type
AK-EK05VD	50 pc. / 1000 pc.	



CERTIFICATES - CERTIFICATEN - APPROBATIONS - ZERTIFIKATE



GERMANY



AUSTRIA



FRANCE



THE NETHERLANDS

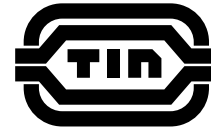

POLAND



DENMARK



ITALY



RUSSIA



SLOVAKIA



ATG SYSTEM CERTIFICATE BELGIUM



NORWAY



FINLAND



HUNGARY



ENGLAND



SWEDEN



USA



ESTONIA



SPAIN



CZECH REPUBLIC



SOUTH AFRICA

INDEX

Article number	Page	Article number	Page	Article number	Page	Article number	Page
03-160212	6	100-200216	5	10PK-403240	26	1-2606	92
03-180214	6	100-F16R-WZ	15	10PK-502050	26	1-3206	92
03-200216	6	100-F20R-WZ	15	10PK-502650	26	11P-181616	76
03-260320	6	100-FLEX26	10	10PK-503250	26	11P-201616	76
03-320326	6	100-ISO4-14-BL	6	10PK-504050	26	11P-201818	76
03-403533	6	100-ISO4-14-RO	6	10PK-632663	26	11P-202016	76
03-504042	6	100-ISO4-16-BL	6	10PK-633263	26	11P-261620	76
03-634554	6	100-ISO4-16-RO	6	10PK-634063	26	11P-262020	76
03-R160212	12	100-ISO4-20-BL	6	10PK-635063	26	11P-262616	76
03-R200216	12	100-ISO4-20-RO	6	10PK-754075	26, 53	11P-262620	76
03-R260320	12	100-ISO4-R16-BL	13	10PK-755075	26, 53	11P-322026	76
04-160212	6	100-ISO4-R16-RO	13	10PK-756375	26, 53	11P-322626	76
04-200216	6	100-MB	18	10PK-904090	26, 53	11PG-201616	92
04-260320	6	100-MBLACK	18	10PK-905090	26, 53	11PK-161414	27
04-320326	6	100-MG16	18	10PK-906390	26, 53	11PK-181616	27
04-403533	6	100-MR	18	10PK-907590	26, 53	11PK-201616	27
04-504042	6	100-R160212	12	10PKG-201620	44	11PK-201818	27
04-634554	6	100-R16MB	14	10PKG-261626	44	11PK-202016	27
04-R160212	12	100-R16MBLACK	14	10PKG-262026	44	11PK-261616	27
04-R200216	12	100-R16MR	14	10PKG-321632	44	11PK-261620	27
04-R260320	12	100-R180214	12	10PKG-322032	44	11PK-262016	27
05-160212	6	100-R18MR	14	10PKG-322632	44	11PK-262020	27
05-160212-GAS	19	100-R200216	12	10PKG-401640	44	11PK-262616	27
05-180214	6	100-R20MB	14	10PKG-402040	44	11PK-262620	27
05-200216	6	100-R20MR	14	10PKG-402640	44	11PK-322026	27
05-200216-GAS	19	10-160212-KB	5	10PKG-403240	44	11PK-322626	27
05-260320	6	10-1604SN	95	10PKS-322632	48	11PK-402032	27
05-260320-GAS	19	10P-161416	76	10PKS-402640	48	11PK-402632	27
05-260320-SPR	20	10P-181418	76	10PKS-403240	48	11PK-403232	27
05-320326	6	10P-181618	76	10PKS-503250	48	11PK-404026	27
05-320326-GAS	19	10P-201620	76	10PKS-504050	48	11PK-404032	27
05-320326-SPR	20	10P-201820	76	10PKS-633263	48	11PK-502040	27
05-403533	6	10P-261626	76	10PKS-634063	48	11PK-502640	27
05-403533-GAS	19	10P-261826	76	10PKS-635063	48	11PK-503240	27
05-403533-SPR	20	10P-262026	76	10PKW-201620	37	11PK-504040	27
05-504042	6	10P-321632	76	10PKW-261626	37	11PK-754040	27, 53
05-504042-SPR	20	10P-321832	76	10PKW-262026	37	11PK-754050	27, 53
05-634554	6	10P-322032	76	10PKW-321632	37	11PK-754063	27, 53
05-634554-SPR	20	10P-322632	76	10PKW-322032	37	11PK-755050	27, 53
05-756063	6	10PG-262026	88	10PKW-322632	37	11PK-755063	27, 53
05-907076	6	10PK-161416	26	10-R160212-KB	13	11PK-756363	27, 53
05-R160212	12	10PK-16JG1016	26	10SK-201620	62	11PK-904040	27, 53
05-R200216	12	10PK-181418	26	10SK-261626	62	11PK-904050	27, 53
05-R260320	12	10PK-181618	25	10SK-262026	62	11PK-904050	27, 53
100-014MB	8	10PK-201420	26	11-200420	95	11PK-904063	27, 53
100-014MBLACK	8	10PK-201620	26	11-260526	95	11PK-904075	27, 53
100-014MR	8	10PK-201820	26	11-260626	95	11PK-905050	26, 53
100-016MB	8	10PK-20JG1020	26	1-1403C	92	11PK-905063	26, 53
100-016MBLACK	8	10PK-261626	26	1-1404	92	11PK-905075	26, 53
100-016MR	8	10PK-261826	26	1-1604	92	11PK-906363	26, 53
100-018MB	8	10PK-262026	26	1-1604Z	92	11PK-906375	26, 53
100-018MR	8	10PK-321632	26	1-1605	92	11PK-907575	26, 53
100-020MB	8	10PK-321832	26	1-1804	92	11PKG-201616	44
100-020MR	8	10PK-322032	26	1-1805	92	11PKG-202016	44
100-121688	5	10PK-322632	26	1-2004	92	11PKG-261620	44
100-140210	5	10PK-401640	26	1-2004Z	92	11PKG-262016	44
100-160212	5	10PK-402040	26	1-2005	92	11PKG-262020	44
100-180214	5	10PK-402640	26	1-2605	92	11PKG-262616	44

INDEX

Article number	Page	Article number	Page	Article number	Page	Article number	Page
11PKG-262620	44	13-2628H-2	95	13PKS-400640	49	14PK-751275	29, 54
11PKG-322026	44	13P-160416	77	13PKS-400640-N	49	14PKG-160416	45
11PKG-322626	44	13P-200420	77	13PKS-400740	49	14PKG-200420	45
11PKG-402032	44	13P-200520	77	13PKS-400740-N	49	14PKG-200520	45
11PKG-402632	44	13P-260420	77	13PKS-500450	49	14PKG-260426	45
11PKG-403232	44	13P-260426	77	13PKS-500450-N	49	14PKG-260526	45
11PKG-404026	44	13P-260526	77	13PKS-500550	49	14PKG-260626	45
11PKG-404032	44	13P-320532	77	13PKS-500550-N	49	14PKG-320532	45
11PKS-403232	48	13P-320632	77	13PKS-500850	49	14PKG-400740	45
11PKS-503240	48	13P-320732	77	13PKS-500850-N	49	14PKS-320532	50
11PKS-504040	48	13PG-200420	89	13PKS-630463	49	14PKS-320532-N	50
11PKW-201616	38	13PG-260426	89	13PKS-630463-N	49	14PKS-400640	50
11PKW-202016	38	13PG-260526	89	13PKS-631063	49	14PKS-400640-N	50
11PKW-261616	38	13PK-160416BP	28	13PKS-631063-N	49	14PKS-400740	50
11PKW-261620	38	13PK-180418BP	28	13PKW-200520	38	14PKS-400740-N	50
11PKW-262016	38	13PK-200420BP	28	13PKW-200520-N	39	14PKS-500850	50
11PKW-262020	38	13PK-200520	28	13PKW-260426	38	14PKS-500850-N	50
11PKW-262616	38	13PK-260420BP	28	13PKW-260426-N	39	14PKS-631063	50
11PKW-262620	38	13PK-260426BP	28	13PKW-260526	38	14PKS-631063-N	50
11PKW-322026	38	13PK-260526	28	13PKW-260526-N	39	14PKW-160416	39
11PKW-322626	38	13PK-320532	28	13PKW-320532	38	14PKW-160416-N	39
11SK-201616	63	13PK-320632	28	13PKW-320532-N	39	14PKW-200420	39
11SK-202016	63	13PK-320732	28	13PKW-320632	38	14PKW-200420-N	39
11SK-261620	63	13PK-400640	28	13PKW-320632-N	39	14PKW-200520	39
11SK-262016	63	13PK-400640-N	29	13SK-160416BP	63	14PKW-200520-N	39
11SK-262020	63	13PK-400740	28	13SK-200420BP	63	14PKW-320532	39
11SK-262616	63	13PK-400740-N	29	13SK-200520	63	14SK-160416	63
11SK-262620	63	13PK-500850	28	13SK-260420BP	63	14SK-200420	63
120-PRT1620	17	13PK-500850-N	29	13SK-260426BP	63	14SK-260426	63
12P-161816	76	13PK-631063	28	13SK-260526	63	15-160212-KB	5
12P-162016	76	13PK-631063-N	29	13-V2622H	96	15P-1414	77
12P-202620	76	13PK-750675	30, 54	13-V2622H-2	96	15P-1616	77
12P-263226	76	13PK-751075	28, 53	14P-160416	77	15P-1818	77
12PK-161816	28	13PK-751275	28, 53	14P-180418	77	15P-2020	77
12PK-162016	28	13PK-901490	28, 53	14P-200420	77	15P-2626	77
12PK-202620	28	13PKG-160416BP	45	14P-200520	77	15P-3232	77
12PK-263226	28	13PKG-200420BP	45	14P-260426	77	15PG-1616	89
12PK-324032	28	13PKG-200520	45	14P-260526	77	15PG-2020	89
12PK-405040	28	13PKG-260420BP	45	14P-260626	77	15PG-2626	89
12PK-407540	28, 53	13PKG-260426BP	45	14P-320532	77	15PG-3232	89
12PK-409040	28, 53	13PKG-260526	45	14P-320632	77	15PK-1414	30
12PK-507550	28, 53	13PKG-320532	45	14PK-160416	29	15PK-1616	30
12PK-509050	28, 53	13PKG-320632	45	14PK-180418	29	15PK-1818	30
12PK-637563	28, 53	13PKG-320732	45	14PK-200420	29	15PK-2020	30
12PK-639063	28, 53	13PKG-400640	45	14PK-200520	29	15PK-2626	30
12PK-759075	28, 53	13PKG-400740	45	14PK-260426	29	15PK-3232	30
12PKG-162016	44	13PKS-260426	49	14PK-260526	29	15PK-4040	30
12PKS-324032	49	13PKS-260426-N	49	14PK-260626	29	15PK-5050	30
12PKS-405040	49	13PKS-320432	49	14PK-320532	29	15PK-6363	30
12PKW-162016	38	13PKS-320432-N	49	14PK-400640	29	15PK-7575	30, 54
12PKW-202620	38	13PKS-320532	49	14PK-400640-N	29	15PK-9090	30, 54
12PKW-263226	38	13PKS-320532-N	49	14PK-400740	29	15PKG-1616	45
12SK-162016	63	13PKS-320632	49	14PK-400740-N	29	15PKG-2020	45
12SK-202620	63	13PKS-320632-N	49	14PK-500850	29	15PKG-2626	45
13-1415-2	95	13PKS-320732	49	14PK-500850-N	29	15PKG-3232	45
13-1615A-2	95	13PKS-320732-N	49	14PK-631063	29	15PKG-4040	45
13-1615HA-2	95	13PKS-400440	49	14PK-631063-N	29	15PKS-2626	50
13-2022HA-2	95	13PKS-400440-N	49	14PK-751075	29, 54	15PKS-3232	50

INDEX

Article number	Page	Article number	Page	Article number	Page	Article number	Page
15PKS-4040	50	16PKG-4032	46	17PK-7510	31, 55	18HNB-14-N	58
15PKS-5050	50	16PKS-3226	50	17PK-7512	31, 55	18P-1404	79
15PKS-6363	50	16PKS-4026	50	17PKG-1604	46	18P-1604	79
15PKW-1616	39	16PKS-4032	50	17PKG-2004	46	18P-1804	79
15PKW-2020	39	16PKS-5032	50	17PKG-2005	46	18P-1805	79
15PKW-2626	39	16PKS-6340	50	17PKG-2605	46	18P-2004	79
15PKW-3232	39	16PKS-6350	50	17PKG-2606	46	18P-2005	79
15-R160212-KB	12	16PKW-2016	40	17PKG-3206	46	18P-2605	79
15SK-1616	64	16PKW-2620	40	17PKG-3207	46	18P-2606	79
15SK-2020	64	16PKW-3216	40	17PKG-4006	46	18P-3206	79
15SK-2626	64	16PKW-3220	40	17PKG-4007	46	18P-3207	79
16HNBA	56	16PKW-3226	40	17PKS-2605	56	18PG-1604	90
16P-1614	78	16SK-2016	64	17PKS-3206	51	18PG-2004	90
16P-1816	78	16SK-2616	64	17PKS-3206-N	51	18PG-2005	90
16P-2014	78	16SK-2620	64	17PKS-3207	51	18PG-2605	90
16P-2016	78	17HNA-10	57	17PKS-3207-N	51	18PG-2606	90
16P-2018	78	17HNA-10-N	57	17PKS-4006	51	18PG-3206	90
16P-2616	78	17HNA-12	57	17PKS-4006-N	51	18PK-1404	32
16P-2618	78	17HNA-12-N	57	17PKS-4007	51	18PK-1604	32
16P-2620	78	17P-1403	78	17PKS-4007-N	51	18PK-1804	32
16P-3216	78	17P-1404	78	17PKS-5008	51	18PK-1805	32
16P-3220	78	17P-1603	78	17PKS-5008-N	51	18PK-2004	32
16P-3226	78	17P-1603	78	17PKS-6310	51	18PK-2005	32
16PG-2016	88	17P-1603DZR	78	17PKS-6310-N	51	18PK-2605	32
16PG-2620	88	17P-1604	78	17PKW-1604	40	18PK-2606	32
16PG-3226	89	17P-1604DZR	78	17PKW-1604-N	40	18PK-3206	32
16PK-1614	30	17P-1804	78	17PKW-2004	40	18PK-3207	32
16PK-1814	30	17P-1805	78	17PKW-2004-N	40	18PK-4006	32
16PK-1816	30	17P-2004	78	17PKW-2005	40	18PK-4006-N	32
16PK-2014	30	17P-2005	78	17PKW-2005-N	40	18PK-4007	32
16PK-2016	30	17P-2605	78	17PKW-2605	40	18PK-4007-N	32
16PK-2018	30	17P-2606	78	17PKW-2605-N	40	18PK-5008	32
16PK-2616	30	17P-3206	78	17PKW-2606	40	18PK-5008-N	32
16PK-2618	30	17P-3207	78	17PKW-2606-N	40	18PK-6310	32
16PK-2620	30	17PG-1604	89	17PKW-3206	40	18PK-6310-N	32
16PK-3216	30	17PG-2004	89	17PKW-3206-N	40	18PK-7506	32, 55
16PK-3220	30	17PG-2005	89	17PKW-3207	40	18PK-7510	32, 55
16PK-3226	30	17PG-2605	89	17PKW-3207-N	40	18PK-7512	32, 55
16PK-4026	30	17PG-2606	89	17SK-1603	64	18PK-9014	32, 55
16PK-4032	30	17PG-3206	89	17SK-1604	64	18PKG-1604	46
16PK-5032	30	17PK-1404	31	17SK-2004	64	18PKG-2004	46
16PK-5040	30	17PK-1604	31	17SK-2005	64	18PKG-2005	46
16PK-6340	30	17PK-1804	31	17SK-2605	64	18PKG-2605	46
16PK-6350	30	17PK-1805	31	17SK-2606	64	18PKG-2606	46
16PK-7540	30, 54	17PK-2004	31	17SKS-2004	65, 68	18PKG-3206	46
16PK-7550	30, 54	17PK-2005	31	17SKS-2005	65, 68	18PKG-3207	46
16PK-7563	30, 54	17PK-2605	31	17SKS-2604	65, 68	18PKG-4006	46
16PK-9040	30, 54	17PK-2606	31	17SKS-2605	65, 68	18PKG-4007	46
16PK-9050	30, 54	17PK-3206	31	17VBS-2005	86, 105	18PKS-2604	51
16PK-9063	30, 54	17PK-3207	31	17VBS-2605	86, 105	18PKS-2604-N	51
16PK-9075	30, 54	17PK-4006	31	17VBS-2606	86, 105	18PKS-2606	51
16PKG-2016	46	17PK-4006-N	31	18HNA-06	58	18PKS-2606-N	51
16PKG-2616	46	17PK-4007	31	18HNA-06-N	58	18PKS-3204	51
16PKG-2620	46	17PK-4007-N	31	18HNA-10	58	18PKS-3204-N	51
16PKG-3216	46	17PK-5008	31	18HNA-10-N	58	18PKS-3206	51
16PKG-3220	46	17PK-5008-N	31	18HNA-12	58	18PKS-3206-N	51
16PKG-3226	46	17PK-6310	31	18HNA-12-N	58	18PKS-3207	51
16PKG-4026	46	17PK-6310-N	31	18HNB-14	58	18PKS-3207-N	51

INDEX

Article number	Page	Article number	Page	Article number	Page	Article number	Page
18PKS-4006	51	1PK-2626	22	25-016MR-KB	10	26P-3206	80
18PKS-4006-N	51	1PK-3232	22	25-020GASMG	19	26P-32Z06	81
18PKS-4007	51	1PK-4040	22	25-020MB	8	26P-32Z07	81
18PKS-4007-N	51	1PK-5050	22	25-020MBLACK	8	26PK-1605	33
18PKS-5008	51	1PK-6363	22	25-020MR	8	26PK-2005	33
18PKS-5008-N	51	1PK-7575	22,51	25-026MB	8	26PK-4008	33
18PKS-6310	51	1PK-9090	22,51	25-026MR	8	26PK-5010	33
18PKS-6310-N	51	1PKG-1616	42	25-032GASMG	19	26PK-6312	33
18PKW-1604	41	1PKG-2020	42	25-032MB	8	26PKW-1605	41
18PKW-1604-N	41	1PKG-2626	42	25-032MR	8	26PKW-2005	41
18PKW-2004	41	1PKG-3232	42	25-160212-GAS	19	26SK-1605	65
18PKW-2004-N	41	1PKG-4040	42	25-160212-KB	5	26SK-2005	65
18PKW-2005	41	1PKS-2626	47	25-200216	5	27HNA	56
18PKW-2005-N	41	1PKS-3232	47	25-200216-KB	5	27HNB	56
18PKW-2605	41	1PKS-4040	47	25-ISO13-32-BL	8	27P-2626	81
18PKW-2605-N	41	1PKS-5050	47	25-ISO13-E20-BL	8	27P-3232	81
18PKW-2606	41	1PKS-6363	47	25-ISO13-E26-BL	8	27PK-4040	33
18PKW-2606-N	41	1PKW-1616	35	25-ISO26-E16-BL	8	27PK-5050	33
18PKW-3206	41	1PKW-2020	35	25-ISO26-E20-BL	8	27PK-6363	33
18PKW-3206-N	41	1PKW-2626	35	25-ISO26-E26-BL	8	27PK-7575	33, 55
18PKW-3207	41	1PKW-3232	35	25-ISO4-26-BL	7	27PK-9090	33, 55
18PKW-3207-N	41	1SK-1616	61	25-ISO4-26-RO	7	27PKG-4040	46
18SK-1604	64	1SK-2020	61	25-ISO4-32-BL	7	27PKS-4040	52
18SK-2004	64	1SK-2626	61	25-ISO4-32-RO	7	27PKS-5050	52
18SK-2005	64	200-121688	5	25-ISO4-R26-BL	13	27PKS-6363	52
18SK-2605	64	200-140210	5	25-ISO4-R26-RO	13	28-201620	96
18SK-2606	64	200-160212	5	25-ISO9-26-BL	7	28-202016	96
18SKS-2004	65, 69	200-180214	5	25-ISO9-26-RO	7	28-262026	96
18SKS-2005	65, 69	200-F16R-WZ	15	25-ISO9-32-BL	7	28-322632	96
18SKS-2604	65, 69	200-F20R-WZ	15	25-ISO9-32-RO	7	28P-14041604-1	81
18SKS-2605	65, 69	200-PRT1620	17	25-ISO9-R26-BL	13	28P-16041604-1	81
19P-1605	79	200-PXC1620	16	25-ISO9-R26-RO	13	28PF-16041604	82
19P-1805	79	200-PXC1720	16	25-MB32	18	28PF-20042004	82
19P-2005	79	200-PXC2020	16	25-MG32	18	28PK-04	33
19PK-1605	32	200-R160212	12	25-MR32	18	28PK-13PK1604BP	34
19PK-2005	32	200-R180214	12	25P-1604	80	28PK-6PK1604BP	34
19PKW-1605	41	20P-1604	79	25P-2004	80	28PV-16031603	82
19PKW-2005	41	2-1616	92	25-R160212-KB	12	28PV-16031603-1	82
19SK-1605	65, 68	21P-1504	79	25-R16MB	14	28PV-16041604	82
19SK-2005	65, 68	2-2020	92	25-R16MR	14	28PV-16041604-1	82
1HNA	56	2-2626	92	25-R20MB	14	29P-1612-CS	82
1HNB	56	22P-1604	79	25-R20MBLACK	14	29P-1615-CS	82
1P-1414	73	22P-2004	79	25-R20MR	14	29P-2018-CS	82
1P-1616	73	2-3232	92	26P-14Z04	80	29P-2022-CS	82
1P-1818	73	240-PXC1820	16	26P-1604	80	29P-2622-CS	82
1P-2020	73	24-1615-S	96	26P-1605	80	2P-1404K	73
1P-2626	73	24-2022	96	26P-16Z03	81	2P-1604	73
1P-3232	73	24-2622	96	26P-16Z04	81	2P-1604K	73
1PG-1616	87	24-2628	96	26P-16Z05	81	2P-1804	73
1PG-2020	87	24P-1604	80	26P-1805	80	2P-2004	73
1PG-2626	87	24P-1804	80	26P-2004	80	2P-2005	73
1PG-3232	87	24P-2004	80	26P-2005	80	2P-2605	73
1PK-1414	25	25-014MB	8	26P-20Z04	81	2PG-1604	87
1PK-1616	22	25-014MR	8	26P-20Z05	81	2PG-1604K	87
1PK-16JG10	22	25-016GASMG	19	26P-2605	80	2PG-2004	87
1PK-1818	22	25-016MB	8	26P-2606	80	2PG-2005	87
1PK-2020	22	25-016MB-KB	10	26P-26Z05	81	2PG-2605	87
1PK-20JG10	22	25-016MR	8	26P-26Z06	81	2PK-1404BP	22

INDEX

Article number	Page	Article number	Page	Article number	Page	Article number	Page
2PK-1603	22	35P-3228P	84	50P-3206	52	50-ISO4-R26-BL	13
2PK-1604BP	22	36P-1612P	84	50P-320604	52	50-ISO4-R26-RO	13
2PK-1604KBP	23	36P-1614P	84	50P-320605	52	50-ISO9-14-BL	7
2PK-1804BP	22	36P-1615P	84	50P43-320604	52	50-ISO9-14-RO	7
2PK-2004BP	22	36P-1616P	84	50-014MB	8	50-ISO9-16-BL	7
2PK-2005	22	36P-2015P	84	50-014MBLACK	8	50-ISO9-16-RO	7
2PK-2605	22	36P-2018P	84	50-014MR	8	50-ISO9-18-BL	7
2PKG-1603	42	36P-2022P	84	500-160212D	5	50-ISO9-20-BL	7
2PKG-1604BP	42	36P-2620P	84	50-016GASMG	19	50-ISO9-20-RO	7
2PKG-1604KBP	42	36P-2622P	84	50-016MB	8	50-ISO9-26-BL	7
2PKG-2004BP	42	36P-3228P	84	50-016MBLACK	8	50-ISO9-26-RO	7
2PKG-2005	42	36PG-1615P	90	50-016MR	8	50-ISO9-R16-BL	13
2PKG-2605	42	36PG-2015P	90	50-018MB	8	50-ISO9-R16-RO	13
2PKW-1604	35	36PG-2022P	90	50-018MR	8	50-ISO9-R18-BL	13
2PKW-1604K	35	36PG-2615P	90	50-020GASMG	19	50-ISO9-R20-BL	13
2PKW-1604-N	35	36PG-2622P	90	50-020MB	8	50-ISO9-R20-RO	13
2PKW-2004	35	37P-1412L	84	50-020MBLACK	8	50-MB20	18
2PKW-2004-N	35	37P-1612L	84	50-020MR	8	50-MB26	18
2PKW-2005-N	35	37P-1615L	84	50-026GASMG	19	50-MBLACK20	18
2PKW-2605-N	35	39P-160450	85	50-026MB	8	50-MBLACK26	18
2S-1604K	61	3EK-050405	99	50-026MBLACK	8	50-MG16	18
2SK-1604BP	61	3P-160416	73	50-026MR	8	50-MG20	18
2SK-2004BP	61	3P-160416VK	74	500-F16R-WZ	15	50-MG26	18
2SK-2005	61	3P-200420	73	500-R160212D	12	50-MR20	18
2SK-2605	61	3P-200420VK	74	50-160212	5	50-MR26	18
30P-1614S	82	3PG-160416	87	50-160212-GAS	19	50-R160212	12
30P-1615S-2	82	3PG-200420	87	50-200216	5	50-R16MB	14
30P-2022S	82	3PK-160416BP	23	50-200216-GAS	19	50-R16MBLACK	14
30P-2622S	82	3PK-200420BP	23	50-260320	5	50-R16MR	14
30PG-1615S-2	90	3PKG-200420BP	43	50-260320-GAS	19	50-R18MB	14
30PG-2022S	90	3PKW-160416	36	50-260320-SPR	20	50-R18MR	14
30PG-2622S	90	3PKW-160416-N	36	50-320326	5	50-R20MB	14
3-1403C	92	3PKW-200420	36	50-320326-GAS	19	50-R20MR	14
3-1404	92	3PKW-200420-N	36	50-320326-SPR	20	50-R260320	12
3-1604	92	3SK-160416BP	61	50-COMBI16	9	50-R26MB	14
3-1804	92	3SK-200420BP	61	50-COMBI16R	14	50-R26MR	14
31P-161616	83	400-F20R-WZ	15	50-ISO13-16-BL	8	5-1604	93
31P-161620	83	40P-1615S	85	50-ISO13-18-BL	8	5-1804	93
31P-201616	83	40P-2022S	85	50-ISO13-20-BL	8	5-2005	93
31P-201620	83	40P-2622S	85	50-ISO13-26-BL	8	5-2606	93
31P-202020	83	4-1414	93	50-ISO13-E18-BL	8	52P16	86
3-2004	92	4-1616	93	50-ISO13-R16-BL	13	52P20	86
3-2005	92	41P-16	85	50-ISO13-R20-BL	13	52P26	86
3-2605	92	41P-20	85	50-ISO13-R26-BL	13	52P32	86
3-2606	92	41P-26	85	50-ISO4-16-BL	6	5-3206	93
3-3206	92	41S-20	71	50-ISO4-16-RO	6	53PK40	34
33P-1605	83	41S-26	71	50-ISO4-18-BL	6	53PK50	34
34P-1604	83	41SKS-20	71	50-ISO4-18-RO	6	53PK63	34
34P-1605	83	41SKS-26	71	50-ISO4-20-BL	6	5P-1404	74
34P-1605-CS	83	4-2020	93	50-ISO4-20-RO	6	5P-1603	74
34P-2004-CS	83	4-2626	93	50-ISO4-26-BL	6	5P-1604	74
34P-2005	84	42P-161615	85	50-ISO4-26-RO	6	5P-1804	74
34P-2005-CS	84	42P-202019	85	50-ISO4-R16-BL	13	5P-2004	74
34P-2605-CS	84	4-3232	93	50-ISO4-R16-RO	13	5P-2005	74
34P-3206	84	43P-161516	86	50-ISO4-R18-BL	13	5P-2605	74
35P-1615P	84	4P-1604	74	50-ISO4-R18-RO	13	5P-3206	74
35P-2018P	84	4P-1804	74	50-ISO4-R20-BL	13	5PG-1604	88
35P-2022P	84	4P-2004	74	50-ISO4-R20-RO	13	5PG-2004	88

INDEX

Article number	Page	Article number	Page	Article number	Page	Article number	Page
5PG-2005	88	6-1804	93	6PKS-5008-N	48	9PK-181818	25
5PG-2605	88	6-2004	93	6PKS-6304	47	9PK-202020	25
5PK-1404	24	6-2005	93	6PKS-6304-N	48	9PK-262626	25
5PK-1604	24	6-2605	93	6PKS-6310	47	9PK-323232	25
5PK-1804	24	6-2606	93	6PKS-6310-N	48	9PK-404040	25
5PK-2004	24	6-3206	93	6PKW-1603	37	9PK-505050	25
5PK-2005	24	6P-1404	75	6PKW-1603-N	37	9PK-636363	25
5PK-2605	24	6P-1604	75	6PKW-1604	37	9PK-757575	25, 53
5PK-3206	24	6P-1804	75	6PKW-1604-N	37	9PK-909090	25, 53
5PK-4007	24	6P-2004	75	6PKW-2004	37	9PKG-161616	43
5PK-4007-N	24	6P-2005	75	6PKW-2004-N	37	9PKG-202020	43
5PK-5007	24	6P-2605	75	6PKW-2005	37	9PKG-262626	43
5PK-5007-N	24	6P-3206	75	6PKW-2005-N	37	9PKG-323232	43
5PK-5008	24	6PG-1604	88	6PKW-2605	37	9PKG-404040	43
5PK-5008-N	24	6PG-2004	88	6PKW-2605-N	37	9PKS-262626	48
5PK-6310	24	6PG-2005	88	6PKW-3206	37	9PKS-323232	48
5PK-6310-N	24	6PG-2605	88	6PKW-3206-N	37	9PKS-404040	48
5PK-7510	24, 53	6PK-1404BP	24	6SK-1604BP	62	9PKS-505050	48
5PK-7512	24, 53	6PK-1603	24	6SK-2004BP	62	9PKS-636363	48
5PKG-1604	43	6PK-1604BP	24	6SK-2005	62	9PKW-161616	37
5PKG-2004	43	6PK-1804BP	24	6SK-2605	62	9PKW-202020	37
5PKG-2005	43	6PK-2004BP	24	7-1404	94	9PKW-262626	37
5PKG-2605	43	6PK-2005	24	7-1604	94	9PKW-323232	37
5PKG-3206	43	6PK-2605	24	7-160416	94	9SK-161616	62
5PKG-4007	43	6PK-3206	24	7-2004	94	9SK-202020	62
5PKS-3206	47	6PK-4007	24	7P-1605	75	9SK-262626	62
5PKS-3206-N	47	6PK-4007-N	25	7P-1605K	75	AB1420	98
5PKS-4007	47	6PK-5007	24	7P-1605L	75	ABEK04	98
5PKS-4007-N	47	6PK-5007-N	25	7P-1805	75	AD-EKEK	98
5PKS-5007	47	6PK-5008	24	7P-2005	75	AK-EK05VD	174
5PKS-5007-N	47	6PK-5008-N	25	8-161616	94	AN1420	99
5PKS-5008	47	6PK-6310	24	8-181818	94	AT1420	98
5PKS-5008-N	47	6PK-6310-N	25	8-202020	94	BA-1288	150
5PKS-6310	47	6PK-7506	24, 53	8HNA-PK40	56	BA-1410	150
5PKS-6310-N	47	6PK-7510	24, 53	8HNA-PK50	56	BA-1612	150
5PKW-1604	36	6PK-7512	24, 53	8HNA-PK63	56	BA-1814	150
5PKW-1604-N	36	6PK-9014	24, 53	8HNA-PK75	56	BA-2016	150
5PKW-2004	36	6PKG-1604BP	43	8HNB-PK90	56	BA-F41	111
5PKW-2004-N	36	6PKG-2004BP	43	8P-1604	75	BAP-CH1616	110
5PKW-2005	36	6PKG-2005	43	9-140414	95	BAP-CH2626	110
5PKW-2005-N	36	6PKG-2605	43	9-160416	95	BAP-H1616	109
5PKW-2605	36	6PKG-3206	43	9-200420	95	BAP-H1818	109
5PKW-2605-N	36	6PKG-4007	43	9-200520	95	BAP-H2020	109
5PKW-3206	36	6PKS-2604	47	9-260526	95	BAP-H2626	109
5PKW-3206-N	36	6PKS-2604-N	48	9HNA	56	BAP-H3232	109
5SK-1604	62	6PKS-3204	47	9HNB	56	BAP-SK1616	110
5SK-2004	62	6PKS-3204-N	48	9P-141414	75	BAP-SK2020	110
5SK-2005	62	6PKS-3206	47	9P-161616	75	BAP-SK2626	110
5SK-2605	62	6PKS-3206-N	48	9P-181818	75	BAP-SV1610S	110
600-PRT1620	17	6PKS-4004	47	9P-202020	75	BCLIP-14	172
600-PRT1720	17	6PKS-4004-N	48	9P-262626	75	BCLIP-16	172
600-PRT1820	17	6PKS-4007	47	9P-323232	75	BCLIP-1820	172
600-PRT2020	17	6PKS-4007-N	48	9PG-161616	88	BCLIP-26	172
600-PXC1620	16	6PKS-5004	47	9PG-202020	88	BCLIP-32	172
600-PXC1720	16	6PKS-5004-N	48	9PG-262626	88	BCLIP-40	172
600-PXC2020	16	6PKS-5007	47	9PG-323232	88	BCLIP-50	172
6-1404	93	6PKS-5007-N	48	9PK-141414	25	BE12HC	159, 166,
6-1604	93	6PKS-5008	47	9PK-161616	25		167

INDEX

Article number	Page	Article number	Page	Article number	Page	Article number	Page
BE12HM	159, 166, 167	BE32	156	CU-SENS	144	M-BMINI2-SLB	163
BE12M-MINI3	163	BE32H	159, 163, 164	DRILLY14	168	M-BMINI3	160
BE14	157	BE32MINI	164	DRILLY16	168	M-BMINI3-F	160
BE14H	159, 165, 166	BE32MINI3	162	DRILLY20	168	M-BMINI3-S	160
BE14M	168	BE40	157	DRILLY26	168	M-BOXBA03	155
BE14MINI3	162	BE50	157	DRILLY32	168	M-BOXBHY	156
BE15C	165	BE63	157	EK12-2	97	M-BOXMINI2	164
BE15HC	159, 166, 167	BE-BOX	159	EK14-2	97	M-BOXMINI3	161
BE15HM	159, 166, 167	BE-MINI	165	EK15	97, 107	M-BOXMINI3-F	162
BE15MMINI	164	BE-MINI3	162	EK16-2	97	M-HP32	166
BE15M-MINI3	163	BE-UNI	158	EK17-2	97	M-LAD03	155
BE15V-MINI3	162	BE-UNISET1	157	EK18-2	97	M-LADMINI3	161
BE16	157	BE-UNISET2	157	EK20-2	97	M-TRANS03	155
BE16H	159, 165, 166	BI-1410	150	EKH16-2	97	M-TRANSMINI2	163
BE16M	168	BI-1612	150	ENDCAP-EK05	71	M-TRANSMINI3	161
BE16MINI	164	BI-1612L	150	H-0212	103	NO4	81
BE16MINI3	162	BI-1814	150	H-0212-S	103	NO5	81
BE18	157	BI-2016	150	HNA	57	NO605	81
BE18C	165	BI-2016L	150	HNA-ECOLINE-SET	59	NCLIP-1618	173
BE18H	159, 165, 166	BI-2620	150	HNA-EK05	58	NCLIP-20	173
BE18HM	159, 166, 167	BM-16	150	HNA-STOP	58	NCLIP-20DOUBLE	173
BE18M	168	BM-18	150	HNA-U	57	NCLIP-26	173
BE18M-MINI3	163	BM-20	150	HNB	57	PH-1632	154
BE18V-MINI3	162	BM-26	150	HNB-STOP	58	PIPEPLUG16	173
BE20	157	BP04	23	HNB-U	57	PK-TOOL04	170
BE20H	159, 165, 167	CU-10ZONEK-230V	138	HN-PEN	57	PK-TOOL05	170
BE20M	168	CU-10ZONEK-24V	138	HNTOOLSET	170	PK-TOOL06	170
BE20MINI	164	CU-12ZONE-RF	143	ISO-BLOCK-L	11	PK-TOOLBOX	170
BE20MINI3	162	CU-6ZONE-230V	137	ISO-BLOCK-S	11	PK-TOOLBOX040506	170
BE22C	165	CU-6ZONE-24V	137	ISO-BOX	83	PLF-P-PK	174
BE22HC	159, 166, 167	CU-6ZONEK-230V	138	JCLIP-1632	172	PLP-P-PK	174
BE22HM	159, 166, 167	CU-6ZONEK-24V	138	JCLIP-1632D	172	PLUG04-B55	168
BE22MMINI	164	CU-6ZONEP-230V	137	JCLIP-1632DL	173	PLUG04-B80	168
BE22M-MINI3	163	CU-6ZONEP-24V	137	KS12M	153	PLUG04-R80	168
BE22V-MINI3	162	CU-8ZONEB-RF	143	KS14M	153	PLUG05-B80	168
BE26	157	CU-8ZONE-RF	143	KS16M	153	PLUG05-R80	168
BE26H	159, 166, 167	CU-ACT-230V	140	KS18M	153	PRESSCHECK1432	168
BE26MINI	164	CU-ACT-230V-PLUG	140, 145	KS20M	153	PS-16	152
BE26MINI3	162	CU-ACT-24V-PLUG	140	KS26M	153	RAD04-100H	107
BE28C	165	CU-ANT	144	KS32M	153	RAD04-100V	107
BE28HC	159, 166, 167	CU-DINRAIL	137, 139	KS40M	153	RAD-B	109
BE28M-MINI3	163	CU-MONO-RF	143	KS50	153	RAD-H	109
BE28V-MINI3	162	CU-PLUGCABLE-15M	141, 145	KS63	153	RADH4-100H	108
		CU-PLUGCABLE-2M	141, 145	KS-K	153	RADK2-R	107
		CU-PLUGCABLE-5M	141, 145	KS-MSET1	152	RADNI-0504	109
		CU-REGB-230V	139	KS-MSET4	152	RADTH-VL	108
		CU-REGB-24V	139	KS-P162026	153	RADV-2-R	108
		CU-REGB-HC230V	139	LB50	10	RS1420PRESS	150
		CU-REGB-HC24V	139	M-BA03	154	RS1420PRESS-N	151
		CU-REGB-RF	143	M-BAT03	154	RS2640PRESS	150
		CU-REGC-230V	140	M-BATMINI2	163	RS32	151
		CU-REGC-24V	140	M-BATMINI3-1.5AH	161	RS63	151
		CU-REGC-RF	144	M-BATMINI3-3.0AH	161	RSEM1420-PERS	151
		CU-REGK-230V	140	M-BH162026	166	RSEM2640-PERS	151
		CU-REGK-24V	140	M-BHY	156	RSEM32	151
		CU-REGS-RF	144	M-BHY162026	156	RSEM63	151
		CU-REPEAT	144	M-BM1620	167	SAFECCUT	151
						SK-B05	70

INDEX

Article number	Page	Article number	Page	Article number	Page	Article number	Page
SK-PIPESTOP16	66	UFH-0505CDP15	130	UFH-060512-RVSD	128	UFH-0626CD03	146
SK-PIPESTOP20	66	UFH-0505CDP16	130	UFH-0605CAF01	131	UFH-0626CD04	146
SK-PIPESTOP26	66	UFH-0505CDWE01	131	UFH-0605CAF04	131	UFH-0626CD05	146
SK-STOPCLIP16	66	UFH-0505CDWE06	131	UFH-0605CD01	130	UFH-0626CD06	146
SK-STOPCLIP16	70	UFH-0505CDWE08	131	UFH-0605CD02	130	UFH-0626CD07	146
SK-STOPCLIP20	66	UFH-0505CDWE09	131	UFH-0605CD03	130	UFH-ADN10	124
SK-STOPCLIP20	70	UFH-0505SLTV07	133	UFH-0605CD04	130	UFH-ANC-05	145
SK-STOPCLIP26	66	UFH-0505SLTV08	133	UFH-0605CD05	130	UFH-ANC-06	145
SK-STOPCLIP26	70	UFH-0505SLTV09	133	UFH-0605CD06	130	UFH-AO03-MZ	127
SPLIT-S16	97	UFH-0505SLTV10	133	UFH-0605CD07	130	UFH-B0605-VN	130
SPLIT-S20	97	UFH-0505SLTV11	133	UFH-0605CD08	130	UFH-B0606-M	126
TESTPLUG16	174	UFH-0505SLTV12	133	UFH-0605CD09	130	UFH-B0606-VN	128
TESTPLUG20	174	UFH-0505SECO07	132	UFH-0605CD10	130	UFH-BEND1218	123
TOOLBOX16202632	158	UFH-0505SECO08	132	UFH-0605CD11	130	UFH-BEND20	123
TOOLBOX405063	158	UFH-0505SECO09	132	UFH-0605CD12	130	UFH-BM0606-VN	129
UFH-0405CDP01	130	UFH-0505SECO10	132	UFH-0605CD13	130	UFH-BS05-M	127
UFH-0405CDP02	130	UFH-0505SECO11	132	UFH-0605CD14	130	UFH-BTM0606-M	126
UFH-0405CDP03	130	UFH-0505SECO12	132	UFH-0605CD15	130	UFH-BTM0606-VN	128
UFH-0405CDP04	130	UFH-0505SECO13	132	UFH-0605CD16	130	UFH-C191645	134
UFH-0405CDP05	130	UFH-0505SECO14	132	UFH-0605CD17	130	UFH-C191800	135
UFH-0405CDP06	130	UFH-0505SECO15	132	UFH-0605CD18	130	UFH-C191974	134
UFH-0405LTV01	133	UFH-0505SECO16	132	UFH-0605CD19	130	UFH-C191976	134
UFH-0405LTV02	133	UFH-0505SSTE07	133	UFH-0605CD20	130	UFH-C192071	135
UFH-0405LTV03	133	UFH-0505SSTE08	133	UFH-0605MDK02	129	UFH-CAB-I1000	148
UFH-0405LTV04	133	UFH-0505SSTE09	133	UFH-0605MDK02	129	UFH-CAB-I400	148
UFH-0405LTV05	133	UFH-0505SSTE10	133	UFH-0605MDK03	129	UFH-CAB-I600	148
UFH-0405LTV06	133	UFH-0505SSTE11	133	UFH-0605MDK03	129	UFH-CAB-I800	148
UFH-0405LTV07	133	UFH-0505SSTE12	133	UFH-0605MDK04	129	UFH-CAB-O1000	148
UFH-0405LTV08	133	UFH-0505SSTN07	132	UFH-0605MDK04	129	UFH-CAB-O400	148
UFH-0405LTV09	133	UFH-0505SSTN08	132	UFH-0605MDK05	129	UFH-CAB-O600	148
UFH-0405LTV11	133	UFH-0505SSTN09	132	UFH-0605MDK05	129	UFH-CAB-O800	148
UFH-0405LTV12	133	UFH-0505SSTN10	132	UFH-0605MDK06	129	UFH-CP	131
UFH-0405SECO01	133	UFH-0505SSTN11	132	UFH-0605MDK06	129	UFH-DH40	123
UFH-0405SECO02	133	UFH-0505SSTN12	132	UFH-0605MDK07	129	UFH-DP200	123
UFH-0405SECO03	133	UFH-060502-MD	125	UFH-0605MDK07	129	UFH-DRY-B	120
UFH-0405SECO04	133	UFH-060502-MR	125	UFH-0605MDK08	129	UFH-DRY-GP100-2	119
UFH-0405SECO05	133	UFH-060502-RVSD	127	UFH-0605MDK08	129	UFH-DRY-VD100	120
UFH-0405SECO06	133	UFH-060503-MD	125	UFH-0605MDK09	129	UFH-ESK060303-M	127
UFH-0405SSTE01	133	UFH-060504-MD	125	UFH-0605MDK10	129	UFH-ESK060303-VN	128
UFH-0405SSTE02	133	UFH-060504-RVSD	128	UFH-0605MDK10	129	UFH-FOIL50	121
UFH-0405SSTE03	133	UFH-060505-MD	125	UFH-0605MDK11	129	UFH-FOIL90	121
UFH-0405SSTE04	133	UFH-060505-MR	125	UFH-0605MDK11	129	UFH-FOIL-ALU	122
UFH-0405SSTE05	133	UFH-060505-RVSD	127	UFH-0605MDK12	129	UFH-FOIL-CLIP25	122
UFH-0405SSTE06	133	UFH-060506-MD	125	UFH-0605MDSS02	128	UFH-FOIL-N	121
UFH-0405SSTN01	132	UFH-060506-MR	125	UFH-0605MDSS03	128	UFH-GKT	126
UFH-0405SSTN02	132	UFH-060506-RVSD	127	UFH-0605MDSS04	128	UFH-H5004	145
UFH-0405SSTN03	132	UFH-060507-MD	125	UFH-0605MDSS05	128	UFH-ISOBOARD-GV	123
UFH-0405SSTN04	132	UFH-060507-RVSD	128	UFH-0605MDSS06	128	UFH-ISOBOARD-S	122
UFH-0405SSTN05	132	UFH-060508-MD	125	UFH-0605MDSS07	128	UFH-ISODRY-25	119
UFH-0405SSTN06	132	UFH-060508-RVSD	128	UFH-0605MDSS08	128	UFH-ISOPRO11	113
UFH-0505CDP07	130	UFH-060509-MD	125	UFH-0605MDSS09	128	UFH-ISOPRO30	113
UFH-0505CDP08	130	UFH-060509-RVSD	128	UFH-0605MDSS10	128	UFH-ISOPRO-AD11	114
UFH-0505CDP09	130	UFH-060510-MD	125	UFH-0605MDSS11	128	UFH-ISOPRO-AD30	114
UFH-0505CDP10	130	UFH-060510-RVSD	128	UFH-0605MDSS12	128	UFH-MAX95	134
UFH-0505CDP11	130	UFH-060511-MD	125	UFH-0605MDSS13	128	UFH-MAXB55	134
UFH-0505CDP12	130	UFH-060511-MR	125	UFH-0605MDSS14	128	UFH-M-D	125
UFH-0505CDP13	130	UFH-060511-RVSD	128	UFH-0605MDSS15	128	UFH-MDK-CON	129
UFH-0505CDP14	130	UFH-060512-MD	125	UFH-0626CD01	146	UFH-P18-GP10	119

INDEX

Article number	Page
UFH-P18-GP18	117
UFH-P18-GP18V	118
UFH-P18-WN	119
UFH-PGKTA	125
UFH-PGKTA-TH	126
UFH-PLUG80	122
UFH-PRO	113
UFH-PRO-ADA	114
UFH-PRO-DIA	113
UFH-PRO-IND	114
UFH-RAS10	115
UFH-RAS15	115
UFH-RAS20	115
UFH-RAS25	115
UFH-RAS-BIND15A	116
UFH-RAS-BIND15B	116
UFH-RAS-CLIP16	116
UFH-RAS-CLIP18	116
UFH-RAS-CLIP20	116
UFH-RAS-CUT	169
UFH-RAS-RB3	116
UFH-RAS-VLE	169
UFH-SCOTCH-66	118
UFH-TACK	118
UFH-TACK-38K	117
UFH-TACK-40	117
UFH-TACK-60	117
UFH-TACK-KLS15	116
UFH-TACK-KLS20	116
UFH-TACK-KLS25	116
UFH-TACK-KLS30	116
UFH-TACK-ROL20	117
UFH-TACK-ROL25	117
UFH-TACK-ROL30	117
UFH-TACK-ROL35	117
UFH-TM050-M	123
UFH-UP-12	120
UFH-UP-14M1	120
UFH-UP-16	120
UFH-UP-16M1	120
UFH-UP-1826M1Z	121
UFH-UP-CUP50	121
UFH-VLA	169
UFH-VLA-STR	169
V-050403-Z	101
V-050404-Z	101
V-050405-Z	101
V-050406-Z	101
V-060402	101
V-060402-Z	101
V-060403	101
V-060404	101
V-060405	101
V-060406	101
V-060407	101
V-060408	101
V-060408-Z	101
V-060409	101

Article number	Page
V-070405-Z	101
V-070406-Z	101
V-070407-Z	101
V-070408-Z	101
V-070410-Z	101
VB050502-BLAUW	104
VB050502-ROOD	104
VB050503-BLAUW	104
VB050503-ROOD	104
VB050504-BLAUW	104
VB050504-ROOD	104
VB060502-BLAUW	104
VB060502-ROOD	104
VB060503-BLAUW	104
VB060503-ROOD	104
VB060504-BLAUW	104
VB060504-ROOD	104
VB-EK05	104
VBS-05	105
VBS050502-BL	105
VBS050502-RO	105
VBS050503-BL	105
VBS050503-RO	105
VBS050504-BL	105
VBS050504-RO	105
VBS-06	105
VBS060502-BL	105
VBS060502-RO	105
VBS060503-BL	105
VBS060503-RO	105
VBS060504-BL	105
VBS060504-RO	105
VDSK-20	70
VDSK-26	70
VEK-050504-Z	102
VEK-050505-Z	102
VEK-050506-Z	102
VEK-050507-Z	102
VEK-050508-Z	102
VEK-050509-Z	102
VEK-060502	102
VEK-060502-Z	102
VEK-060502-ZV	103
VEK-060503	102
VEK-060503-Z	102
VEK-060504	102
VEK-060504-Z	102
VEK-060505	102
VEK-060505-Z	102
VEK-060506	102
VEK-060506-Z	102
VEK-060507	102
VEK-060507-Z	102
VEK-060508	102
VEK-060508-Z	102
VEK-060509	102
VEK-060509-Z	102
VEK-060510	102

Article number	Page
VEK-060510-Z	102
VISION SET 16	66
VISION SET 20	66
VISION SET 26	66
VISION-KEY16	66
VISION-KEY20	66
VISION-KEY26	66
VR-EK05	104
VS-05	103
VS-0504	103
VS-06	103
VS-0604	103
VS-0605	103
VS-07	103
VS-ENDCAP	69
VS-ENDCAP-M	70
VSK-1616	67
VSK-161616	67
VSKEK-0502	67
VSKEK-0503	67
VVSK-20	68
VVSK-20-90	69
VVSK-26	67
VVSK-26-90	69
VVSK-T202020	69
VVSK-T20M20	68
VVSK-T262626	69
VVSK-T26M26	68
WBP-1604	86
WBP-2004	86
WBS-1604	99

WE CARE TO CONNECT



Henco Industries NV | Toekomstlaan 27, 2200 Herentals | Tel. +32 14 28 56 60 | www.henco.be

Technische veranderingen en drukfouten voorbehouden

Technical amendments and printing errors reserved

Changements techniques et fautes d'impression sous réserve

Technische Änderungen und Druckfehler vorbehalten